

TOTO

TOTO U.S.A., Inc. 1155 Southern Road Morrow, GA 30260
Phone : (770) 282-8686

Warranty Registration and Inquiry

For product warranty registration, TOTO U.S.A. Inc. recommends On-Line Warranty Registration. Please visit our web site <http://www.totousa.com>. If you have questions regarding warranty policy or coverage, please contact TOTO U.S.A. Inc., Customer Service Department, 1155 Southern Road, Morrow, GA 30260 (888) 295 - 8134 or (678) 466 - 1300 when calling from outside of U.S.A.

TOTO

WASHLET

Instruction Manual



washlet

SW4047AT60
SW4047T60

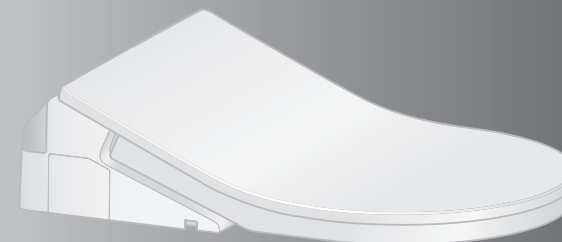

SW4049AT60
SW4049T60

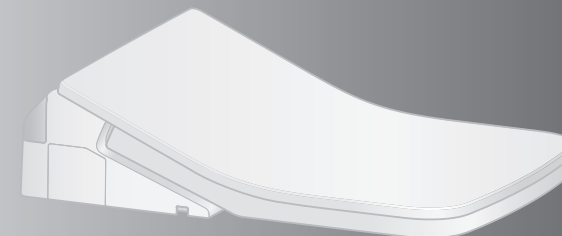

- You are advised to record the following information to allow quick service.

Date of purchase :	Name of shop :
Date : year month day	Tel : ()

- Thank you for your recent purchase of this product.
Please read the enclosed information to ensure the safe use of your product.
- Be sure to read this Instruction Manual before using your product and keep it in a safe place for future reference.

The available functions vary according to the part no.

Check your model's part no. and write a check mark in this field as needed.

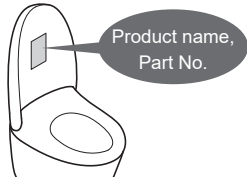

Functions		Product name (Model)		Ref. Page		
		Part No.	WASHLET			
Your Model		SW4047AT60 SW4049AT60	SW4047T60 SW4049T60			
Basic Functions	Cleansing	Rear cleansing			16	
		Rear soft cleansing	●	●		
		Front cleansing				
	Changing the cleansing method	Wand position adjustment			16	
		Water pressure adjustment				
		Oscillating cleansing	●	●		
		Pulsating cleansing				
		Personal setting lock				
	Changing the temperature	Temperature adjustment	●	●	20, 21	
	Sanitary Functions	Removing odors	Deodorizer	●	●	18, 19
"ewater+" cleaning		Auto wand CLEAN	●	●		
Bowl pre-cleaning		Pre-mist	●	●		
Convenience Functions	Flushing	Remote control flushing	●	-	17	
		Auto flushing	●*1		18, 19	
	Heating the toilet seat	Heated seat	●	●	-	
		Save energy by lowering the toilet seat temperature	Auto energy saver			22, 23
			Auto energy saver+	●	●	
Timer energy saver						
Maintenance	Wand cleaning	●	●	28		

*1 Auto flush is not available when using the toilet from a standing position.

Keep It Clean

Sanitary Toilet

Lights to show that the "CLEAN" functions are operating.



The self-cleaning functions operate automatically.
(See pages 18,19 for details.)

	As you sit	As you stand up
Removing odors inside the bowl unit.	Deodorizer	Auto power deodorizer
A mist is automatically sprayed inside the bowl unit to make it more difficult for dirt to adhere.	Pre-mist	
Cleans the wand with "ewater+"		Auto wand CLEAN

Table of Contents



Safety Precautions	4	Introduction
Operational Precautions	11	
Parts Names	12	
Preparation	14	Operation
Basic Operations	16	
Automatic Functions (Cleaning Features, Convenience Features)	18	
Deodorizer, Auto wand CLEAN, Pre-mist, Auto flushing		
Temperature Adjustment (Toilet Seat, Warm Water)	20	
Energy Saver Features	22	Maintenance
Maintenance	26	
●Main Unit	27	
●Wand	28	
Wand cleaning		
●Deodorizing Filter	28	Reference
●Water Filter Drain Valve	29	
Changing Settings	30	
What to Do?	36	
●If the water does not flow due to a water service interruption	36	
●If you cannot operate with the remote control	36	
●Freeze Damage Prevention	37	
●Long Periods of Disuse	38	
●Removal of Operation Guide	40	
Troubleshooting	41	
Specifications	46	
Warranty	47	

Safety Precautions



IMPORTANT SAFEGUARDS

READ ALL INSTRUCTIONS BEFORE USING

Symbols and Meanings

	WARNING	May result in death or serious injury.
	CAUTION	May result in injury or property damage.

The following symbols are used to indicate important safety instructions for the use of the product.

Symbol	Meaning
	This symbol indicates a prohibited use of the product.
	This symbol is used to indicate a required step in the use of this product.

WARNING

	<p>Do not touch the connection of power cord with wet hands.</p> <ul style="list-style-type: none"> • Doing so may cause electrical shock.
	<p>Do not get any water or cleaning solution on the main unit or connection of power cord.</p> <ul style="list-style-type: none"> • Doing so may cause fire, electrical shock, heat or short circuit. • Doing so may cause the product to crack resulting in injury or water damage.
	<p>Never disassemble, repair or alter.</p> <p>Doing so may cause fire, electrical shock, overheating, short circuit or breakdown.</p>
	<p>Do not install the product on moving vehicles such as wheeled vehicles or boats.</p> <ul style="list-style-type: none"> • Doing so may cause fire, electric shock, short circuit or malfunction. • The toilet seat, toilet lid, main unit, or other parts may come loose and fall off, resulting in injury.

WARNING

	<p>Do not use the product if a malfunction occurs.</p> <ul style="list-style-type: none"> • In case of breakdown or other problems, be sure to cut off power by flipping the power switch to OFF. Close the water shutoff valve to stop water supply. Possible malfunctions: <ul style="list-style-type: none"> – Water is leaking from a pipe or the main unit. – The product is cracked or broken. – The product makes a strange noise or emits a strange odor. – The product emits smoke. – The product is abnormally hot. – The toilet seat cushion is out of place. • Continued use after malfunction could cause a fire, electric shock, heat, short circuit, injury or water damage.
	<p>Do not use other water than allowed by the laws and ordinances of the region of use. Only Use potable water.</p> <p>Do not use seawater or recycled water.</p> <ul style="list-style-type: none"> • Doing so may cause irritation to the skin and malfunction.
	<p>Do not touch the connection of power cord during thunderstorms.</p> <ul style="list-style-type: none"> • Doing so may cause electrical shock.
	<p>Do not allow the water supply hose to touch the connection of power cord.</p> <ul style="list-style-type: none"> • Doing so may cause condensation resulting in a fire, electrical shock, heat or a short.
	<p>Do not do anything that may damage the power plug.</p> <p>Do not strike, yank, twist, excessively bend, damage, alter, or heat the power cords.</p> <p>Also, do not place anything heavy on, bind or pinch the power cords.</p> <ul style="list-style-type: none"> • Using a damaged power cord may result in a fire, electrical shock, heat or short.
	<p>Do not use any power supply other than the one specified.</p> <p>AC 120 V, 60 Hz</p> <ul style="list-style-type: none"> • Doing so may cause fire or excessive heat.
	<p>Keep cigarettes and other open flames away from the product.</p> <ul style="list-style-type: none"> • Failure to do so may cause fire.
	<p>Refrain from sitting on the seat for long periods.</p> <ul style="list-style-type: none"> • It may cause low-temperature burns. To prevent the following persons from getting a moderate temperature burn during use, other person should turn off the toilet seat heater. <ul style="list-style-type: none"> – Young children, the aged and other users unable to set the temperature appropriately themselves. – The ill, physically disabled and others who do not have freedom of movement. – Those using any medicines that cause drowsiness (sleeping or cold medicine), those who have been drinking heavily, anyone severely fatigued and anyone else liable to fall asleep.

Safety Precautions (Continued)

WARNING

This is an electrical product. Do not install it anywhere water is likely to get on the product or anywhere with humidity high enough that water is likely to form on the surface of this product. When using the product in a bathroom, install a fan or ventilation port and ensure good air flow through the bathroom.

- Failure to do so may cause fire or electrical shock.

Always connect the product to the cold water supply.

- Connecting to hot water supply may result in burns and equipment damage.

Check that the power cord is connected correctly.

- Failure to do so may cause fire, heat or short circuit.
(When installing this product, observe the local laws and regulations regarding installation.)

If the power cord is damaged, avoid danger by having the manufacturer's repair department or equivalent specialist replace it.

Always flip the power switch to OFF before maintenance or inspection.

- Failure to do so may cause electrical shock or malfunction.

When leaking battery fluid adheres to your body or clothes, wash it away with clean water.

- The fluid may damage your eyes or skin.

Preliminary studies in females suggest that overuse of continuous spraying can increase the possibility of vaginal mucosa drying and potential reduction in desirable microbial organisms.

Although these studies have not been validated, please consult your healthcare provider for concerns regarding whether these circumstances may apply to you.

More importantly, if you are an individual suffering from any immune deficiency as a result of disease, chemotherapy, or other medical condition compromising the immune system you should consult your healthcare provider before use of this product.



CAUTION

Do not use the product if the main unit is unstable.

- Doing so may cause the main unit to come loose and fall, resulting in injury.
(If there is backlash in the main unit, consult the installer, seller, or TOTO customer service. see contact information on the back cover.)

If the product is damaged, do not touch the damaged section.

- Doing so may cause electrical shock or injury.
Replace it immediately.

Do not apply strong force, mechanical shock, step on or stand on the toilet seat, toilet lid or main unit. Also do not place any heavy object on the toilet seat, toilet lid or main unit.

- Doing so may cause cracking or cause the main unit to come loose and fall, resulting in injury.
- Doing so may damage the product and cause injury or water damage.

Do not lift up this product by the toilet seat or lid.

Do not raise the toilet seat or lid while objects are resting on top of the unit.

- Doing so may cause the main unit to come loose and fall, resulting in injury.

When maintaining the plastic parts (main unit etc.) or the water supply hose, use a neutral kitchen detergent diluted with water. Do not use any of the following.

Toilet cleaner, household cleaner, benzene, paint thinner, powdered cleanser or nylon scrubbing brush.

- These items may damage or crack the plastic and cause injury or malfunction.
- These items could damage the water supply hose and cause a water leak.

To prevent a sudden water leak, do not remove the water filter drain valve when the shutoff valve is open.

- Doing so will cause water to spurt out.
(Refer to Page 29 for instructions on cleaning the water filter drain valve.)

Do not fold or crush the water supply hose; do not damage by cutting with a sharp object.

- Doing so may cause water leaks.



Safety Precautions (Continued)

CAUTION

If a water leak should occur, always close the shutoff valve.

When the ambient temperature is likely to drop to 32 °F (0 °C) or lower, prevent damage to the pipes and hoses due to freezing.

- Frozen water pipes could cause the main unit and the pipes to break, resulting in a water leak.
- Regulate the room temperature to prevent the pipes and hoses from freezing during cold months.
- Drain the water.

When not using the product for a long time, close the shutoff valve, drain the water from the main unit and water supply hose, and then flip the power switch to "OFF".

- When using the product again, allow the product to refill with water first. Otherwise, the water in the tank might become contaminated and cause skin inflammation or other problems. (Refer to Page 39 for instructions on replenishing the water.)
- Leaving the power on may cause fire or heat.

When installing the water filter drain valve, make sure that it is securely tightened in its proper position.

- Failure to securely tighten it may cause a water leak.

If the bowl unit is clogged, flip the power switch to OFF and remove the clog.

- If the "Auto flushing"^{*1} is activated, it would make the wastewater in the bowl unit overflow and may result in water damage.
- Use commercially available tools that are made for unclogging the bowl unit to remove the clogging.

Make sure of the plus and minus signs on the batteries before inserting them. Remove depleted batteries immediately.

When replacing the batteries:

Replace both batteries with new ones.

Use the same brand for both new batteries (any brand available).

- Failure to do so may cause the batteries to leak fluid, generate heat, rupture, or ignite.

When the product is supposed not to be used for long time, remove the batteries from the remote control.

- Failure to do so may cause the batteries to leak fluid.

DANGER To reduce the risk of electrocution:

1. Do not use while bathing.
2. Do not place or store the product where it can fall or be pulled into a tub or sink.
3. Do not place in or drop into water or other liquid.
4. Do not reach for the product when it has fallen into water. Unplug it immediately.

WARNING To reduce the risk of burns, electrocution, fire or injury to persons:

1. Close supervision is necessary when this product is used by, on, or near children or invalids.
2. Use this product only for its intended use as described in this manual. Do not use attachments not recommended by the manufacturer.
3. Never operate this product if it has a damaged cord or plug, is not working properly, has been dropped or damaged, or has been dropped in water. Return the product to a service center for examination and repair.
4. Keep the cord away from heated surfaces.
5. Never block the air openings on the product or place it on a soft surface, such as a bed or couch, where the air openings may be blocked. Keep the air openings free of lint, hair, and other similar items.
6. Never use while sleepy or drowsy.
7. Never drop or insert any object into any opening or hose.
8. Do not use outdoors. Do not operate where aerosol (spray) products are being used or where oxygen is being administered.
9. Connect this product to a properly grounded outlet only.
See "Grounding Instructions" in Page 10.
10. The tank should be filled with water only.

- Servicing should be performed by an authorized service representative.
- This product is for household use.

*1 Only applies to toilets with an "Auto flushing" function

Safety Precautions (Continued)

Grounding Instructions

This product should be grounded. In the event of an electrical short circuit, grounding reduces the risk of electric shock by providing an escape wire for the electrical current.

The plug must be plugged into an outlet that is properly installed and grounded.

⚠ DANGER - Improper use of the grounding plug can result in a risk of electric shock.

If repair or replacement of the cord or plug is necessary, do not connect the grounding wire to either flat-head terminal.

Check with a qualified electrician or serviceman if the grounding wire instructions are not completely understood, or if in doubt as to whether the product is properly grounded.

This product is factory equipped with a specific electric cord and plug to permit connection to a proper electric circuit. Make sure that the product is connected to an outlet having the same configuration as the plug.

No adapter should be used with this product. Do not modify the plug provided - if it will not fit in the outlet, have the proper outlet installed by a qualified electrician.

If the product must be reconnected for use on a different type of electric circuit, the reconnection should be made by qualified service personnel.

If it is necessary to use an extension cord, use only a three wire extension cord that has a three blade grounding plug, and a three-slot receptacle outlet that will accept the plug on the product.

Replace or repair a damaged cord.

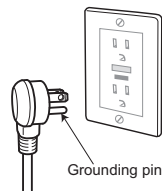

SAVE THESE INSTRUCTIONS

Operational Precautions

■ For prevention of malfunctions

- Do not block the remote control transmitter or receiver.

< About the seat switch >

- When you sit on the toilet seat, the seat switch turns ON, enabling you to use various features. (A click sound is heard when the seat switch is ACTIVATED.)

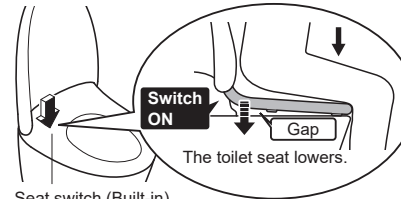

Seat switch (Built-in)

- Sit back on the toilet seat.
 - The seat switch will not turn on unless you sit on the seat properly.



Note

- When a child uses the product, the seat switch may not be ACTIVATED by their light body weight.
- Since the toilet seat is designed to move up and down, a clearance is provided between the toilet seat cushion and the bowl unit.

■ For prevention of damage

- Wipe plastic areas such as the main unit and remote control with a soft cloth tightly wrung out with water.
- Do not lean against the toilet lid.



■ For prevention of malfunctions and failures

- Flip the power switch to OFF if there is a risk of lightning.
- A toilet seat cover or a toilet lid cover cannot be used. (The seat switch may not function properly.)



- Do not urinate on the main unit, toilet seat or wand. (Doing so may cause a failure or discoloration.)
- Do not apply strong forces to the control panel of the remote control.
- When using a toilet cleaner to clean the toilet, rinse it off within 3 minutes and leave the toilet seat and toilet lid open. (If vapor from a toilet cleaner enters the main unit, it may cause a malfunction.)
 - Wipe off any cleaner that remains on the bowl unit.
- Do not expose to direct sunlight. (Doing so may cause changes in color, irregular heated seat temperature, remote control malfunction or the product malfunction due to the change in temperature.)
- Use radios, etc. away from the product. (The product could cause interference with the radio signal.)
- If you use a booster seat for infants or a soft highchair, remove it after use. (Keeping it installed may prevent some of the functions from being used.)
- Do not apply force to the remote control. (May cause malfunction.)
 - To prevent the remote control from being dropped, set it in the hanger when you are not using it. Be careful not to expose it to water.
- Do not place anything on the toilet seat and lid, and do not press them with hands. (Failure to do so may turn on the seat switch, causing the floor to get wet if buttons on the remote control are touched and warm water comes out from the wand.)

Parts Names

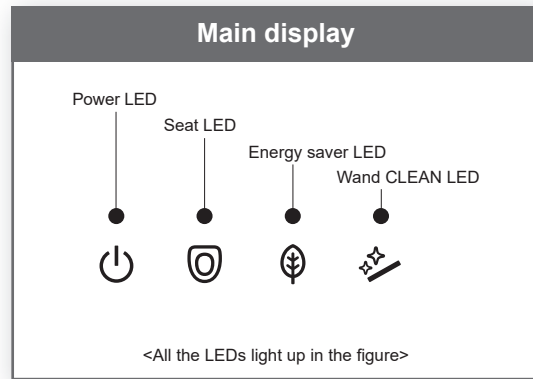

Product name, part no., etc.

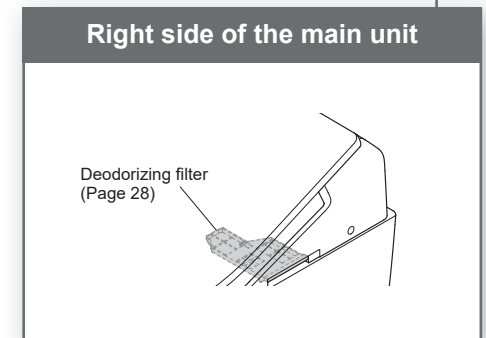
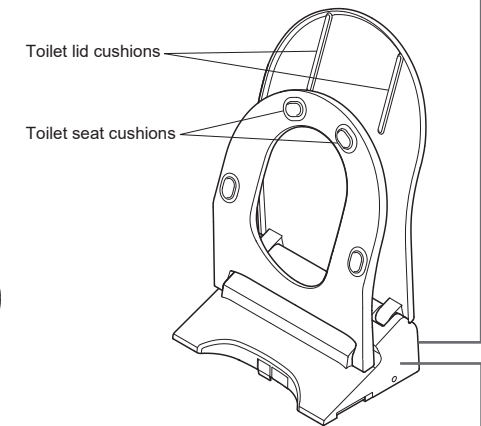
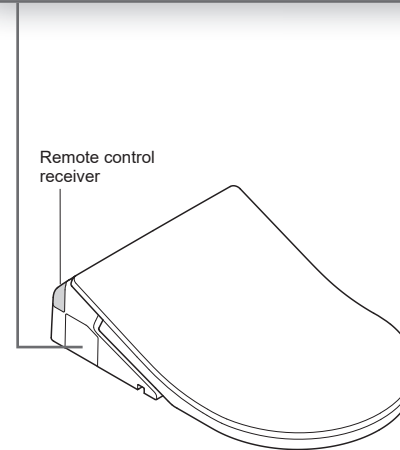
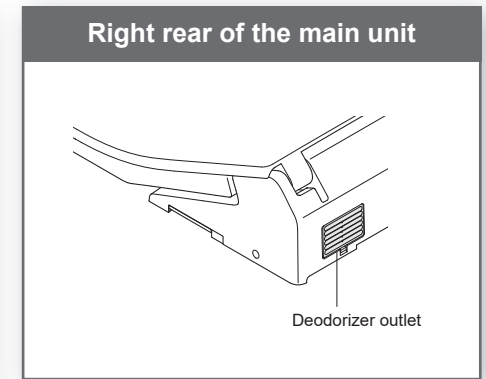
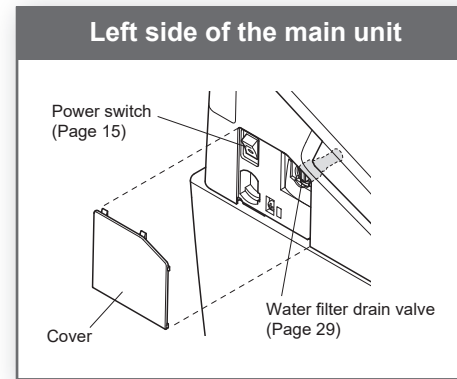
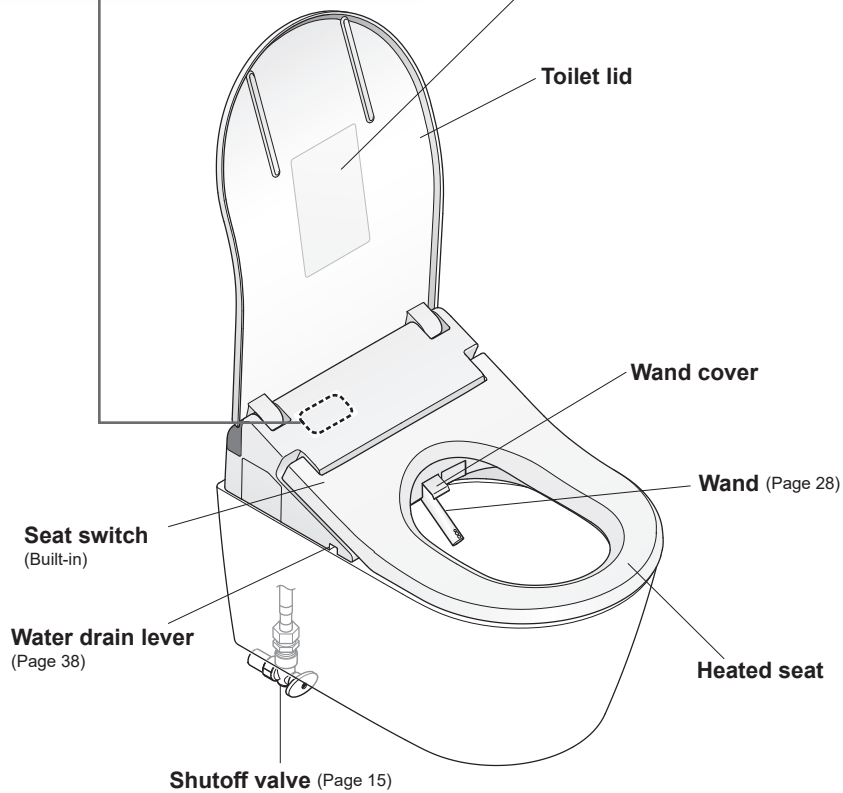

Descriptions in this manual are based on the illustrations of SW4047AT60 and SW4047T60. The toilet seat and the toilet lid shape varies by model.

Preparation

Using the Product for the First Time

1. Insert the battery

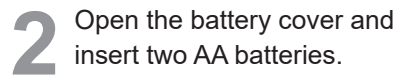
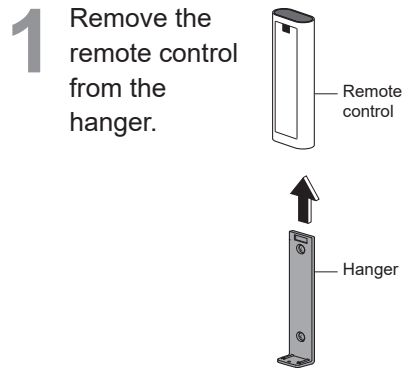

• When batteries are properly loaded, all the LEDs on the remote control light up for about 2 sec.

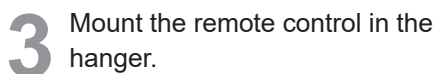

■ About the batteries

- Use dry cell, alkaline batteries.
- Be sure to follow "Safety Precautions" to prevent the batteries from rupturing or leaking fluid. (Pages 6, 8)

If the remote control is secured (for anti theft)

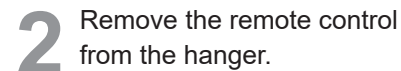
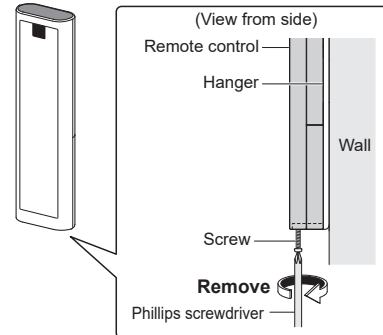
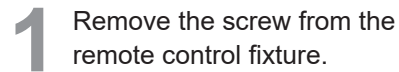

■ To secure the remote control again

Tighten and fix the screw.
(Overtightening may cause damage to parts such as the hanger.)

2. Turn on the power

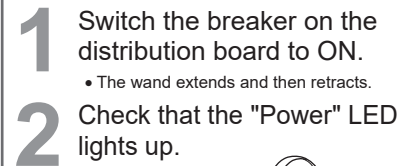

<If the light is off>

- (1) Remove the cover on the left side of the main unit, and flip the power switch to ON.

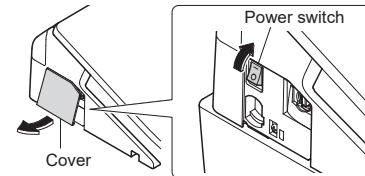

- (2) Reinstall the cover. (Page 27)

<If the light is off but, the power switch is "ON">

- Switch "Power" to "ON" using the remote control.

To operate from the back of remote control

- Press "Power ON/OFF" button about 3 seconds or longer.

To operate from the front of remote control

- Recommended if the remote control is secured to prevent theft, etc.
- Press "Oscillating cleansing" button about 10 seconds or longer.

3. Open the shutoff valve

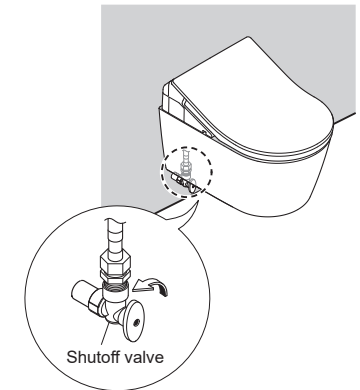
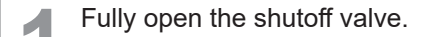

To turn the power "OFF"

Remove the cover on the left side of the main unit, and flip the power switch to "OFF".

- The "POWER" LED goes off.

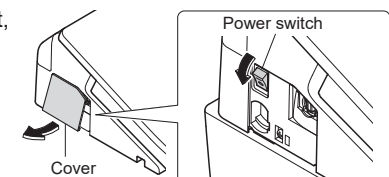

Basic Operations

Operate the controls on the remote control; a beep sounds when the main unit receives the signal.

Stopping

- "Stopping"
Stops the operation.

Cleansing

- 🚿 "Rear cleansing"
Cleanses your rear.
- 🚿 "Rear soft cleansing"
Cleanses your rear with mild water pressure.
- The setting changes between 🚿 and 🚿 each time the 🚿 is pressed.
- 🚿 "Front cleansing"
Serves as a bidet for ladies.

"Wand CLEAN"

Cleans the wand with "ewater+".

- The wand can be automatically cleaned when you use the cleansing functions (Rear cleansing, Front cleansing, etc.). (Page 18)

Personal setting lock

👤 👤 You can store your preferred "Wand position", "Water pressure" and "Warm water temperature" settings.

- To store a settings
While cleansing is in progress, set your preferred "Wand position", "Water pressure" and "Warm water temperature" and then press and hold 👤 or 👤 for 2 seconds or longer.
- To use
Press 👤 or 👤 and then press the button for the cleansing you want to use.
- The "Wand position" and "Water pressure" lamps will light up for about 10 seconds in their set positions, and the "Warm water temperature" display switches.

● Functions that operate when a button is pressed during "Rear cleansing", "Rear soft cleansing" or "Front cleansing".

Note

- Sitting back on the toilet seat makes it easier to adjust the wand position and to reduce splashing.

"Oscillating cleansing"

The wand moves back and forth to cleanse your rear thoroughly.

"Pulsating cleansing"

Cleanses with the water pressure pulsating between soft and strong.

- The setting changes between "ON" and "OFF" each time the button is pressed.

"Water pressure adjustment"

□ □ □ □ □
- +

You can adjust the water pressure to one of five levels. ([-] Softer, [+] Stronger)

- After you press the "Water pressure adjustment" button, the set position will light for 10 seconds.
- A light will also flash for about 10 seconds to indicate the current setting when any of the cleansing buttons (rear cleansing, rear soft cleansing, front cleansing) are pressed.

"Wand position adjustment"

□ □ □ □ □
▲ ▼

You can adjust the washing position to 5 different points between the front and the rear, using the [▲] and [▼] buttons.

- After you press the "Wand position adjustment" button, the set position will light for 10 seconds.
- A light will also flash for about 10 seconds to indicate the current setting when any of the cleansing buttons (rear cleansing, rear soft cleansing, front cleansing) are pressed.

TOTO

*1 Remote control transmitter (Front side, Top side)

Flushing^{*2}

- 🌀 "Full flush"
Performs a full flush.
- 🌀 "Light flush"
Performs a light flush.

This section is an overview of the settings that can be configured with the remote control.

- See the corresponding pages for the detailed descriptions.

Temperatures

Adjust temperatures (Page 20)

- 🌡️ "Toilet seat temperature"
- 💧 "Warm water temperature"

Auto functions^{*2}

For changing Settings (Page 32)

- 🌀 "Auto flushing"
- 🔌 "Power ON/OFF"

- Pressing it about 3 seconds or longer turns the power on/off.
- If the remote control is secured to prevent theft (Page 15 Step 2-2)

Energy Saver

Saving energy (Page 24)

- 🕒 "Timer energy saver"
- 🌿 "Auto energy saver"
- 🌿 "Auto energy saver+"

"Setting confirmation"

- The current setting can be discerned from the LEDs.

"Wand cleaning"

- To clean the wand with it extended. (Page 28)

Remote control back side

- 🔋 Low battery warning mark (Page 36)

*2 Except SW4047T60 and SW4049T60.

Automatic Functions

Cleaning Features, Convenience Features

"ewater+"^{*1} is used automatically to clean the wand.

- Operation under the initial settings is described below.

As you approach



As you sit^{*2}



As you stand up



Lights to show that the "CLEAN" functions are operating.

"Wand CLEAN" LED

Lights to show that the "Auto wand CLEAN" functions or the "Wand CLEAN" functions are operating.



During "Auto wand CLEAN" or "Wand CLEAN": Flashes

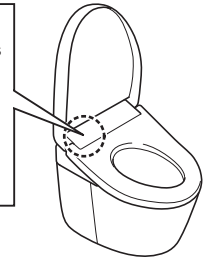

Note

- Deodorizing filter needs regular maintenance. (Page 28)

Changing settings

- "Deodorizer" ON/OFF
- "Auto power deodorizer" ON/OFF (Page 34 for all)

<p>Removing odors inside the bowl unit</p> <h3>Deodorizer</h3>	<p>Starts the deodorizer</p>	<p>Starts the auto power deodorizer (After about 10 seconds) →It stops after about 60 seconds</p>		<ul style="list-style-type: none"> • "Deodorizer" ON/OFF • "Auto power deodorizer" ON/OFF (Page 34 for all) 	
<p>Cleans the wand with "ewater+"^{*1}</p> <h3>Auto wand CLEAN</h3>		<p>Cleans the wand automatically (After about 25 seconds)</p> <ul style="list-style-type: none"> • Only when the cleansing functions are used. →The wand extends and "ewater+"^{*1} comes out from the base of the wand. 	<ul style="list-style-type: none"> • When the cleansing functions (Rear cleansing and Front cleansing etc.) have not been used in 8 hours, the wand is cleaned automatically. (Water comes out from around the wand.) 	<ul style="list-style-type: none"> • "Auto wand CLEAN" ON/OFF (Page 32) 	<p>"ewater+" can also be used by pressing the remote control button</p> <p>Press "Wand CLEAN" button</p> <p>(After wand cleaning, water comes out from around the wand.)</p> <ul style="list-style-type: none"> ● To clean the wand with it extended. →"Wand cleaning" (Page 28)
<p>A mist is sprayed inside the bowl unit to make it more difficult for dirt to adhere</p> <h3>Pre-mist</h3>	<p>Pre-mist →A mist is sprayed inside the bowl unit</p>		<ul style="list-style-type: none"> • The pre-mist will not spray for about 90 seconds after you stand up from the toilet seat. 	<ul style="list-style-type: none"> • "Pre-mist" ON/OFF (Page 32) 	
<p>Flush automatically</p> <h3>Auto flushing^{*3}</h3>		<p>The toilet flushes^{*4} (After about 10 seconds)</p>	<ul style="list-style-type: none"> • Auto flush is not available in the following cases. → • About 60 seconds after the toilet is flushed. (After 60 seconds have passed, flush using the remote control.) • When the time spent sitting on the toilet seat is less than about 6 seconds. (Flush with the remote control.) • The flushing varies depending on how long you sit on the toilet seat. Around 6 - 30 seconds: "Light flush" Around 30 seconds or more: "Full flush" 	<ul style="list-style-type: none"> • "Auto flushing" ON/OFF • "Auto flush delay" (5 seconds, 10 seconds or 15 seconds) (Page 32 for all) 	<p>*1 What is meant by "ewater+" ? "ewater+" helps the self-cleaning wand feature working effectively and preventing the dirt accumulation causing the stains.</p> <ul style="list-style-type: none"> ● "ewater+" is generated from Potable water. ● "ewater+" helps to minimize dirty surfaces, but does not make cleaning unnecessary. ● The effect and duration vary depending on the usage environment and conditions. <p>*2 Water comes out from the area around the wand for several seconds while water is warmed up.</p> <p>*3 Except SW4047T60 and SW4049T60.</p> <p>*4 Auto flush is not available when using the toilet from a standing position.</p>

Temperature Adjustment

Toilet Seat, Warm Water

Three different temperature levels (High, Medium, Low) and "OFF" setting can be made.

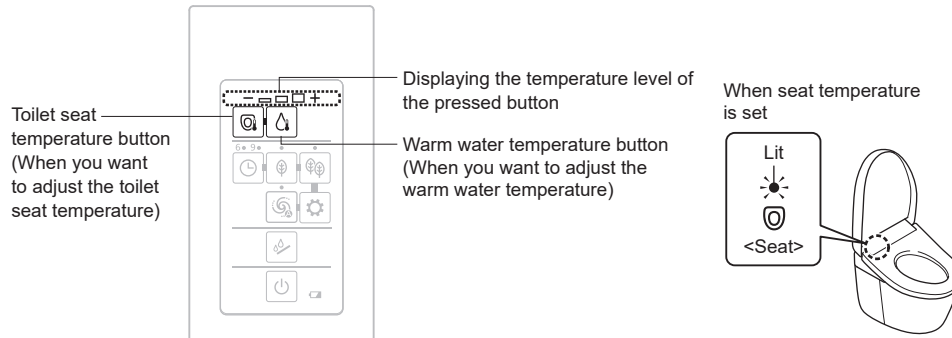

Adjusting the temperature

- 1 Remove the remote control from the hanger.
 - If the remote control is secured to prevent theft. (Page 14)
- 2 Choose and press the button of the temperature that you want to set from the ("Toilet seat temperature" button), ("Warm water temperature" button).
 - The current temperature level appears.
- 3 Press the button selected in step 2 repeatedly until a desired temperature level lights up.

The setting changes each time the button is pressed once

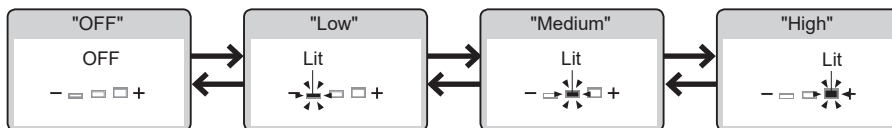

If the button is not pressed for about 10 seconds, the "Temperature adjustment" LED will go off, but the setting will be retained.
 If the "Temperature adjustment" LED goes out before the setting is completed, start all over again at step 2.

<Settings complete>

- 4 Mount the remote control in the hanger.
 - If the remote control is secured to prevent theft. (Page 14)

To turn the warm water temperature*1 and toilet seat temperature "OFF"

- 1 Remove the remote control from the hanger.
 - If the remote control is secured to prevent theft. (Page 14)
- 2 Select a temperature button you want to turn "OFF" from ("Toilet seat temperature" button), ("Warm water temperature" button) and press it.
 - The current temperature level appears.
- 3 Press the button selected in step 2 repeatedly until the temperature level is set to "OFF".

The setting changes each time the button is pressed once

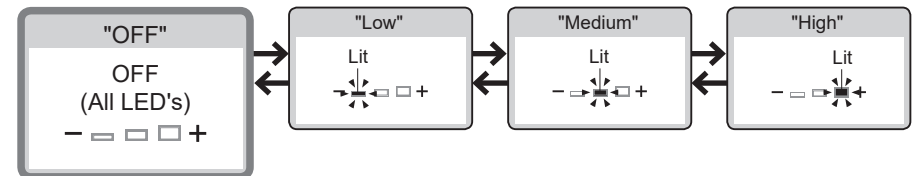

<Settings complete>

- 4 Mount the remote control in the hanger.
 - If the remote control is secured to prevent theft. (Page 14)

*1 To prevent condensation, the water temperature does not drop below 68 °F (20 °C) even when set to "OFF".

● If adjusting the temperature does not warm up the toilet seat.
 → Is the energy saver set to "ON"? (Page 22)

Energy Saver Features Type

"Auto energy saver", "Auto energy saver+" or "Timer energy saver" can be selected.

To save energy, the temperature of the toilet seat becomes low (or "OFF").

- "Auto energy saver" takes about 10 days to detect time periods in which the toilet seat is never or infrequently used.

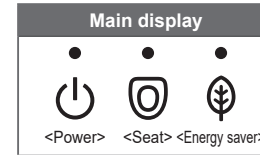

Type	Situation	Energy saver is on	When energy saver is in operation		AM		PM				
			Main display	Toilet seat heater	0	4	6	8	5	9	0
Auto energy saver	You want the product to save energy automatically. The product detects time periods with infrequent use and lowers the toilet seat temperature automatically.		→	 	Example: Used infrequently from 9 pm to 6 am 						
Auto energy saver+	You want to save more energy. In addition to the "Auto energy saver" feature, it automatically turns off the toilet seat heater during time periods when the toilet is never used.		→	 	Example: Not used from 0 am to 4 am 						
Timer energy saver	You want to save energy only for the preset duration of time. (6 hours, 9 hours) Once the time is set, the toilet seat heater turn off automatically during the set time period every day.		→	 	Example: Set from 8 am to 5 pm 						
Timer energy saver and Auto energy saver / Auto energy saver+	You want to save a lot of energy with "Auto energy saver" and "Timer energy saver". When both "Timer energy saver" and "Auto energy saver / Auto energy saver+" are set, "Auto energy saver / Auto energy saver+" operates when "Timer energy saver" is not operating.		→	<ul style="list-style-type: none"> ● During "Auto energy saver / Auto energy saver+": Same LED indication as "Auto energy saver / Auto energy saver+" (see above) ● During "Timer energy saver": Same LED indication as "Timer energy saver" (see above) 	Example: When "Timer energy saver" and "Auto energy saver+" are used together 						

- Even if the energy saver feature is on (i.e., the toilet seat heater is set to "Low" or "OFF"), the toilet seat is heated to the set temperature in about 15 minutes.
(The LED indication on the main display returns to the state for when the energy saver is on.)

*1 The toilet seat temperature set on page 20.

*2 The time period when the toilet seat heater is set to a "Low".

*3 The time period when the toilet seat heater is set to a "OFF".

Operation

Energy Saver Features How to Set

Remote control back side

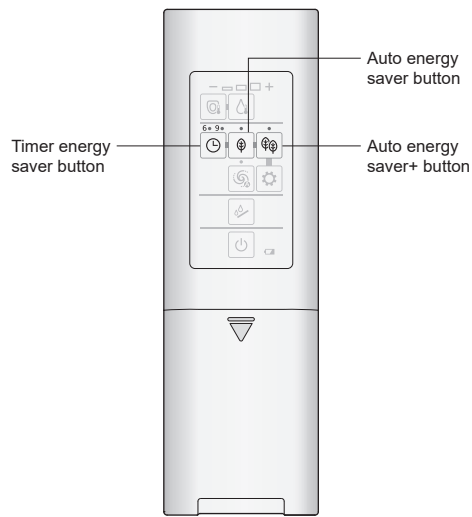

Auto energy saver

1  Press "Auto energy saver" button.

The setting changes each time the button is pressed once

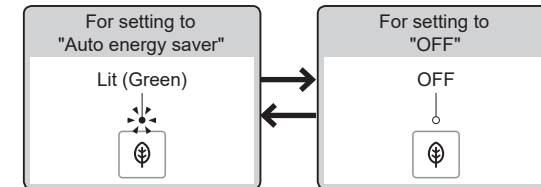

Auto energy saver+

1  Press "Auto energy saver+" button.

The setting changes each time the button is pressed once

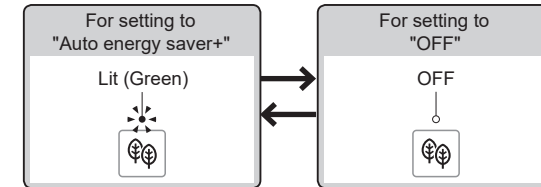

Timer energy saver

● Set the Energy saver at the time you want to start it.

Example: To save energy from 1 am to 7 am (for 6 hours)

1  When 1:00 AM comes, Press "Timer energy saver" button.

• Press the "Timer energy saver" button repeatedly until the "6" LED lights up.

The setting changes each time the button is pressed once

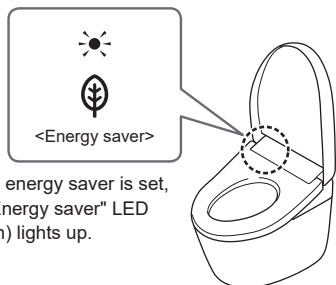
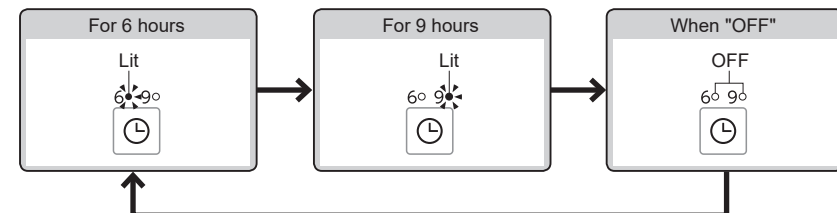

When energy saver is set, the "Energy saver" LED (green) lights up.

Maintenance

⚠ WARNING

! Always flip the power switch to OFF before maintenance or inspection.
(Failure to do so may cause electric shock or malfunction, resulting in a breakdown.)

For safety, flip the power switch to OFF before maintenance.*1

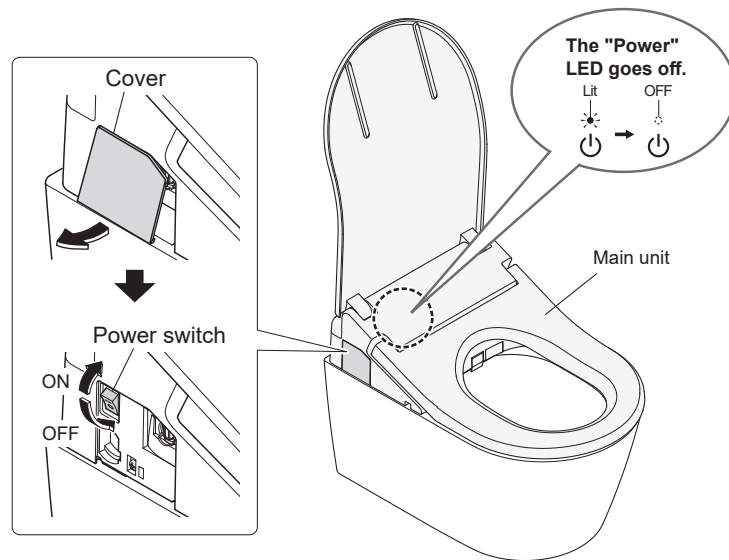

Do not use a dry cloth or toilet paper on plastic parts.
(May cause damage.)



*1 Except when using "Wand cleaning".

Main Unit

Main Unit (Approximately daily)

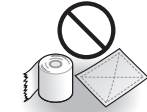

- Toilet paper
- Dry cloth
- Nylon scrubbing brush
(May cause damage.)

1 Remove the cover on the left side of the main unit, and flip the power switch to "OFF". (Page 26)

2 Wipe with a soft cloth that has been soaked in water and wrung out thoroughly.

■ For heavy dirt

- Wipe with a soft cloth soaked in diluted, neutral kitchen detergent, and then wipe with a soft cloth soaked in water.



- Paint thinner
- Benzene
- Powdered cleanser

3 Flip the power switch to ON. (Page 26)

- The "Power" LED lights up.

4 Reinstall the cover.

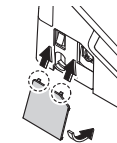

Attention!

- This product is an electric appliance. Be careful not to let water seep inside or leave detergent in the gap between the main unit and bowl unit. (May damage plastic parts or cause a malfunction.)
- When using a toilet cleaner to clean the toilet, rinse it off within 3 minutes and leave the toilet seat and toilet lid open.
 - Wipe off any cleaner that remains on the bowl unit. (If vapor from a toilet cleaner enters the main unit, it may cause a malfunction.)
- Do not push or pull the covers around the wand with undue force. (May cause damage or malfunction.)
- Wipe the back surface of the toilet seat and the toilet seat cushions with a soft cloth tightly wrung out with water.
(Otherwise adhesion of dirt may result in discoloration.)

Maintenance

Wand

Deodorizing Filter

Water Filter Drain Valve

Wand (Approximately once a month)

<If you notice dirt (Wand cleaning)>



Soft cloth

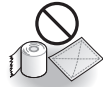

Toilet paper, etc. (May cause damage.)

1 Extend the wand.

To operate from the back of remote control



Press "Wand cleaning" button.

To operate from the front of remote control

- Recommended if the remote control is secured to prevent theft, etc.

(1) ■ Press "Stopping" button until all LEDs on the remote control start flashing. (about 10 seconds)

(2) Press "Front cleansing" button about 3 seconds or longer.

- The wand extends and water flows out for cleaning.
- The wand automatically retracts after about 5 minutes.

2 Wipe with a soft, wet cloth.

- Do not pull, push or press the wand with excessive force. (May cause damage or malfunctions.)

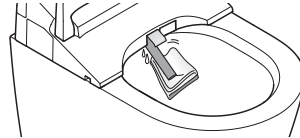

3 ■ Press "Stopping" button on the front side of the remote control.

- The wand retracts.

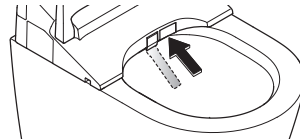

Deodorizing Filter (Approximately once a month)

1 Remove the cover on the left side of the main unit, and flip the power switch to "OFF". (Page 26)

2 Remove the deodorizing filter.

- Hold the knob and pull outward.
- Do not pull with undue force. (May cause damage or malfunction.)

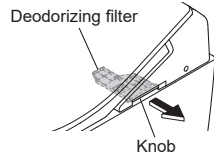

4 Mount the deodorizing filter.

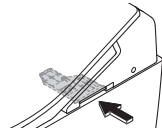

Push firmly until a click sound is heard.

5 Flip the power switch to ON. (Page 26)

- The "Power" LED lights up.

6 Reinstall the cover. (Page 27)

3 Clean with a tool such as a toothbrush.

- When washing with water, dry off all water before mounting.

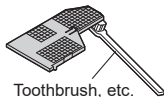

Toothbrush, etc.

Water Filter Drain Valve (Approximately once every 6 months)

<If you think the water pressure has weakened>

1 Close the shutoff valve. (Page 41)

- The water supply stops.

CAUTION



Do not remove the water filter drain valve while the shutoff valve is open. (Otherwise, water may leak out)

2 Press "Wand CLEAN" button.

(Release the pressure from the water supply pipe.)

3 Remove the cover on the left side of the main unit, and flip the power switch to "OFF". (Page 26)

4 Remove the water filter drain valve.

- Loosen the water filter drain valve with a flat-head screwdriver and then pull it.

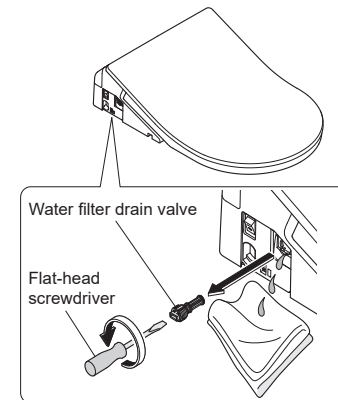

5 Clean the filter with a tool such as a toothbrush.

- Also, remove any dust from inside the hole of the water filter drain valve.

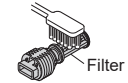

6 Reinstall the water filter drain valve.

- Insert the water filter drain valve and use a flat-head screwdriver to tighten it securely.

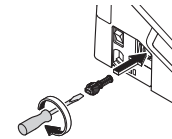

7 Flip the power switch to ON. (Page 26)

- The "Power" LED lights up.

8 Reinstall the cover. (Page 27)

9 Open the shutoff valve. (Page 15)

Changing Settings

Setting List

Setting Types			Available Settings Bold: Initial settings	Applicable Models	How to Set Ref. Page
Auto functions	Auto flushing	Auto flushing	ON/OFF	SW4047AT60 SW4049AT60	Page 32
		Auto flush delay	5seconds 10seconds 15seconds		
	Cleaning Features	Auto wand CLEAN	ON/OFF	All models	
		Pre-mist	ON/OFF		
		Deodorizer	ON/OFF		
Auto power deodorizer	ON/OFF	Page 34			
Other settings	Beep sound		ON/OFF		
	Personal setting lock		ON/OFF		

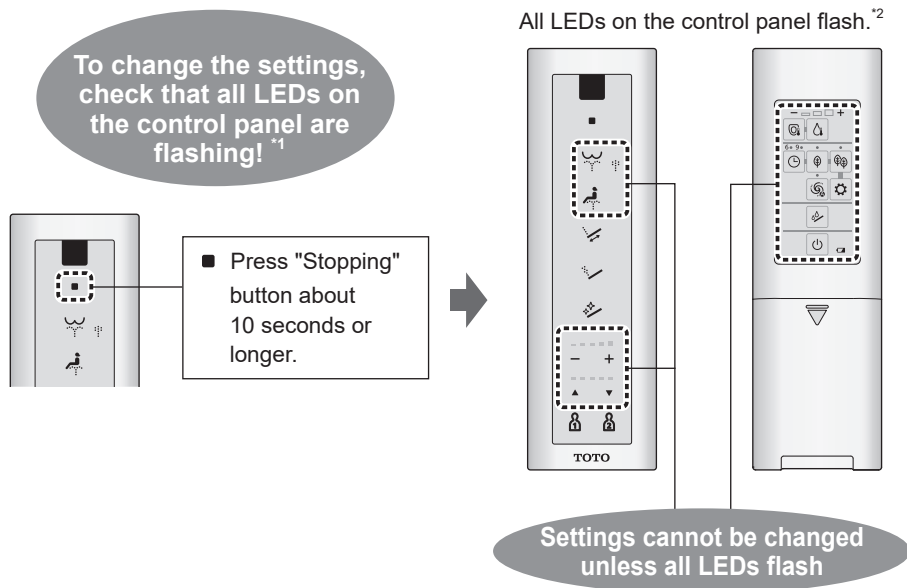

*1 Some settings are excluded.

*2 During setting, if the next button is not pressed within about 60 seconds, the light will stop flashing. If you fail to complete the setting, redo from the step 1.

Changing Settings

- 1** ■ Press "Stopping" button until all LEDs on the remote control start flashing. (about 10 seconds)

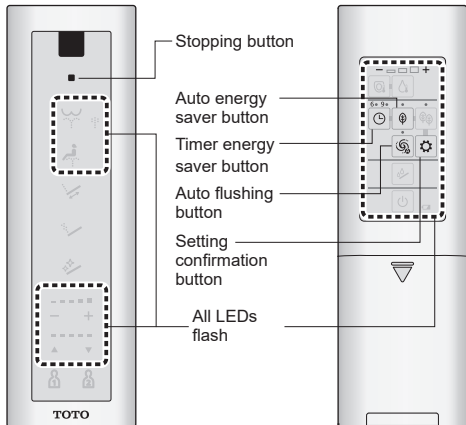

Auto flushing

Set whether or not to clean the bowl unit automatically
Auto flushing

- 1**  Press "Auto flushing" button.

The setting changes each time the button is pressed once

Set whether or not to clean the bowl unit automatically

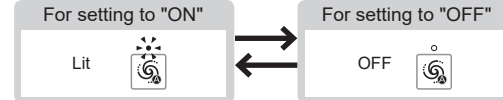

<Settings complete>

Check by the "Auto flushing" LED

Change the amount of time before the toilet flushes automatically
Auto flush delay

- 2**  Press "Auto flushing" button.

The setting changes each time the button is pressed once

Change the amount of time before the toilet flushes automatically

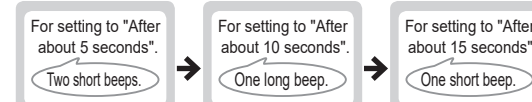



- 3** ■ Press "Stopping" button.

<Settings complete>

Cleaning Features

Set whether or not to clean the wand automatically
Auto wand CLEAN

- 2**  and  Press "Timer energy saver" button and "Setting confirmation" button at the same time.

The setting changes each time the button is pressed once

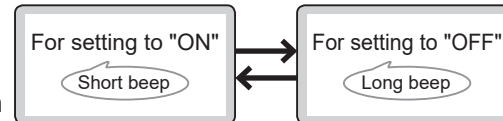

Set whether or not to clean the wand automatically



- 3** ■ Press "Stopping" button.

<Settings complete>

Set whether or not to spray mist in the bowl unit automatically
Pre-mist

- 2**  and  Press "Auto energy saver" button and "Setting confirmation" button at the same time.

The setting changes each time the button is pressed once

Set whether or not to spray mist in the bowl unit automatically

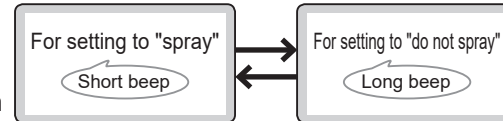

<Settings complete>

Changing Settings

- 1 ■ Press "Stopping" button until all LEDs on the remote control start flashing. (about 10 seconds)

Cleaning Features (Continued)

Set whether or not to deodorize automatically after sitting on the toilet seat

Deodorizer

- 2  Press "Wand cleaning" button about 5 seconds or longer.

The setting changes each time the button is held down longer than 5 seconds.

Set whether or not to deodorize automatically after sitting on the toilet seat

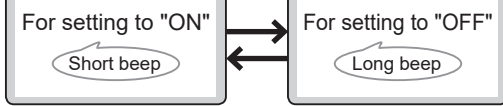

Set whether or not to power deodorize automatically after standing up

Auto power deodorizer

- 2  Press "Toilet seat temperature" button.

The setting changes each time the button is pressed once

Set whether or not to power deodorize automatically after standing up

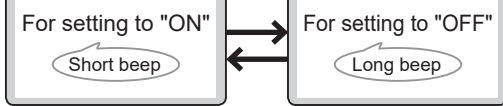

- 3 ■ Press "Stopping" button. <Settings complete>

Other settings

Set whether or not to make a beep sound

Beep sound *1

- 2  Press "Rear cleansing" button.

The setting changes each time the button is pressed once

Set whether or not to make a beep sound

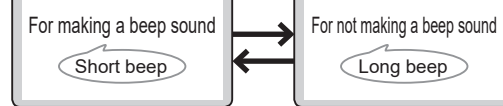

- 3 ■ Press "Stopping" button. <Settings complete>

Set whether or not to use the personal setting lock

Personal setting lock

- 2  Press "Personal setting lock 2" button for 5 seconds or longer.

The setting changes each time the button is held down longer than 5 seconds.

Set whether or not to use the personal setting lock

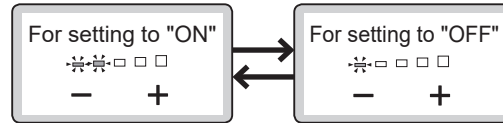

Check by the "Water pressure" LED

- 3 ■ Press "Stopping" button. <Settings complete>

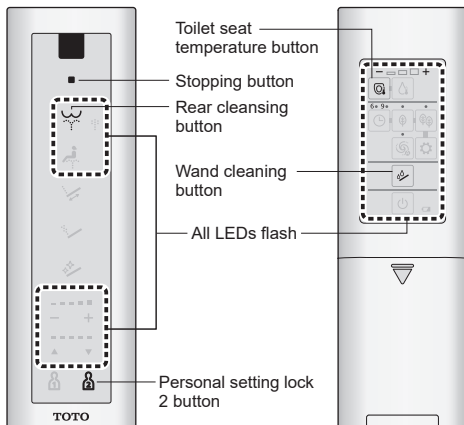

*1 When you change each of the settings, set the electronic sound to "Make a beep sound".

What to Do?

If the water does not flow due to a water service interruption

If you cannot operate with the remote control

If the water does not flow due to a water service interruption

- 1 Use a bucket to flush water.
- 2 If the water level is low after flushing, add more water.
 - Prevents odors.

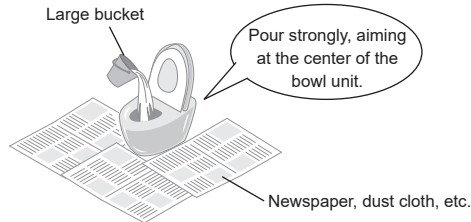

Attention!

- Before starting to work, set "Auto flushing" to "OFF" (Except SW4047T60 and SW4049T60). (Page 32)
- When the water supply is restored, be sure to perform a flush. (To prevent waste from remaining in the drain pipe.)

If you cannot operate with the remote control

- If the low battery warning mark "  " on the back of the remote control is flashing, please replace the batteries.

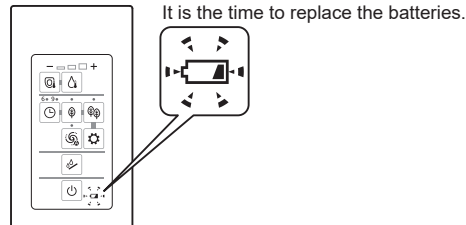

■ Replacing the batteries

- 1 Remove the cover on the left side of the main unit, and flip the power switch to "OFF". (Page 15)
- 2 Remove the remote control from the hanger. (Page 14)
- 3 Open the battery cover and replace the two AA batteries. (Page 14)
 - The low battery warning mark goes off.
- 4 Mount the remote control in the hanger.
- 5 Flip the power switch to ON. (Page 15)
 - The "Power" LED lights up.
- 6 Reinstall the cover. (Page 27)

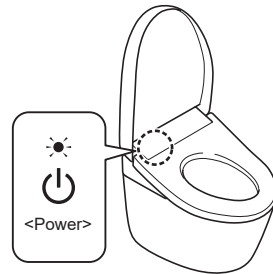

Attention!

- "ON" and "OFF" settings of the functions such as the energy saver function may be canceled when the batteries are replaced. Set them again.



Freeze Damage Prevention

When the ambient temperature is likely to drop to 32 °F (0 °C) or lower, take measures to prevent freezing.

Attention!

- When the ambient temperature is likely to drop to 32 °F (0 °C) or lower, do not use the energy saver feature. (May damage the product.)
- Warm the bathroom or take measures against freezing so that the ambient temperature does not drop below 32 °F (0 °C).
- Before starting to work, set "Auto flushing" to "OFF" (Except SW4047T60 and SW4049T60). (Page 32)

How to freeze damage prevention

- 1 Close the shutoff valve. (Page 41)
 - The water supply stops.
- 2  Press "Wand CLEAN" button. (Release the pressure from the water supply pipe.)
- 3 Remove the cover on the left side of the main unit, and flip the power switch to "OFF". (Page 15)
- 4 Remove the water filter drain valve.
 - Loosen the water filter drain valve with a flat-head screwdriver and then pull it.
- 5  **CAUTION**
Do not remove the water filter drain valve while the shutoff valve is open. (Otherwise, water may leak out.)
- 6 Flip the power switch to ON. (Page 15)
 - The "Power" LED lights up.
- 7 Reinstall the cover. (Page 27)
- 8 Set the toilet seat temperature to "High". (Page 20)
 - To maintain the temperature, close the toilet seat and toilet lid after finishing work.

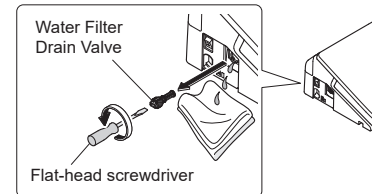
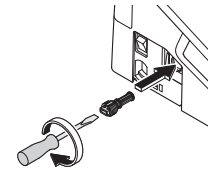

■ To use the product again

- The water needs to be resupplied. (Page 39)

What to Do?

Long Periods of Disuse

If the toilet is in a location you will not visit for a long time, drain the water.
(The water in the tank may cause malfunctions or become contaminated and cause skin irritation or other problems.)

How to drain the water

- 1 Close the shutoff valve. (Page 41)
 - The water supply stops.

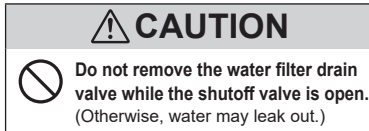

- 2  Press
"Wand CLEAN" button.
(Release the pressure from the water supply pipe.)

- 3 Remove the cover on the left side of the main unit, and flip the power switch to "OFF". (Page 15)

- 4 Remove the water filter drain valve.
 - Loosen the water filter drain valve with a flat-head screwdriver and then pull it.

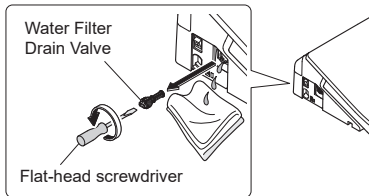

- 5 When water draining is completed, reinstall the water filter drain valve.
 - Insert the water filter drain valve and use a flat-head screwdriver to tighten it securely.

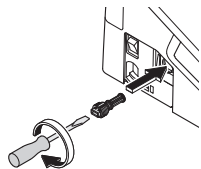

- 6 Reinstall the cover. (Page 27)

- 7 Pull out the water drain lever.
 - Water comes out from around the wand.
(about 20 seconds)

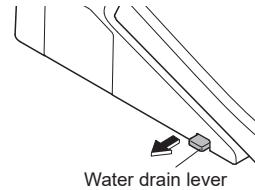

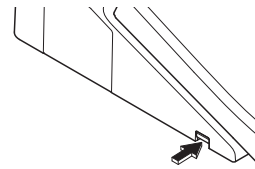

- 8 Release your hand to return the water drain lever to its original position.



- **If water may get frozen**
 - Add antifreeze solution in the water in the bowl to prevent freezing.
(The antifreeze solution should not be flushed out. Collect it before using the toilet and dispose of it.)
- **To use the product again**
 - The water needs to be resupplied. (Page 39)

Resupplying the Water

- 1 Open the shutoff valve. (Page 15)
 - Check that water is not leaking from a pipe or the main unit.
- 2 If the power is not on,
 - (1) Remove the cover on the left side of the main unit, and flip the power switch to "ON". (Page 15)
 - The "Power" LED lights up.
 - (2) Reinstall the cover. (Page 27)
- 3 Discharge water from the wand.
 - (1) Pressing down the left side of the toilet seat,
 - (2)  Press "Rear cleansing" button to discharge water from the wand.
 - Catch the water in a paper cup or other receptacle.
 - (3)  Press "Stopping" button.
 - **If the remaining water has frozen and no water comes out**
 - Heat the inside of the bathroom, and warm the water supply hose and shutoff valve using a cloth soaked in warm water.

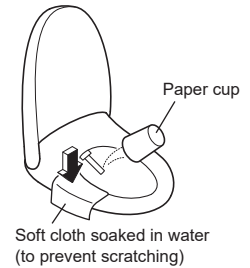

What to Do?

Removal of Operation Guide

To remove, follow the procedure below.

How to remove the operation guide

- 1 Remove the cover on the left side of the main unit, and flip the power switch to "OFF". (Page 15)
- 2 Remove the remote control from the hanger. (Page 14)
- 3 Remove the hanger and operation guide.

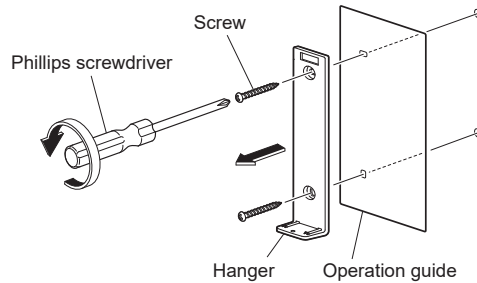

- 4 Screw the hanger on the wall.

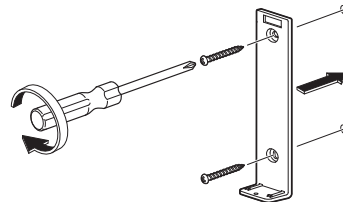

- 5 Mount the remote control in the hanger.

- 6 Flip the power switch to ON. (Page 15)
 - The "Power" LED lights up.

- 7 Reinstall the cover. (Page 27)

■ To install back the operation guide, follow the procedure above. (Install the operation guide at step 4.)

Troubleshooting

First, try the actions described on pages 41 - 45. If the problem persists, consult the installer, seller, or TOTO customer service (see contact information on the back cover).

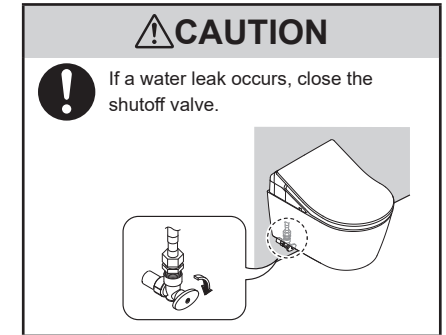

Please check first

Is the Power LED lit?

- Is the breaker on the distribution board turned on?
 - Check whether there is a power outage or the breaker has turned "OFF".
- Is the power switch flipped to "OFF"?
 - Flip it to "ON". (Page 15 Step 2-2)
- Is the "Power ON/OFF" setting "OFF"?
 - Switch it to "ON" with the remote control. (Page 15 Step 2-2)

Is the Energy saver LED lit?

- While the LED is lit, energy saver (Page 22) is in operation, so the toilet seat temperature may be reduced or the heater may be turned off.

Is the remote control working?

- Is the " " LED on the backside of the remote controller flashing?
 - Replace the batteries. (Page 14, 36)

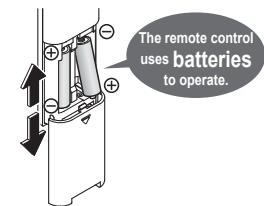

- Is the remote control transmitter or the remote control receiver blocked?

→ Remove obstructions, dirt, water droplets or any other blockages.

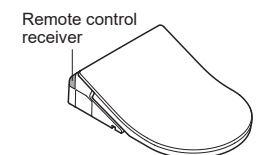
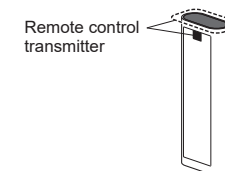

Troubleshooting

Rear Cleansing, Front Cleansing and Wand

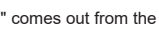
Trouble	Please check	Ref. Page
The wand (or cleansing water) does not come out	● When the temperature is low, it takes time for the wand to come out after the remote control button is pressed because the water must be warmed up first.	-
	● Did you sit on the toilet continuously for 2 hours or longer? (If so, operation is stopped for safety purposes.) → Stand up from the seat and then use again.	-
	● If the water supply pressure drops significantly, for example if water is used elsewhere or if there is a water failure, the function may stop for safety. → Flip the power switch to OFF and wait about 10 seconds before flipping it on again. If the same symptom reappears. → There may be a malfunction. Consult with TOTO customer service (see contact information on the back cover).	15
	● The seat switch will not turn on unless you sit on the seat properly. → Sit back on the toilet seat.	11
	● Are you using a toilet seat cover, a toilet lid cover or a seat for infants? → Remove any covers. When using a seat for infants or a soft highchair, remove after each use.	11
	●  Are you pressing "Wand CLEAN" button? ●  When you press "Wand CLEAN" button, "ewater+" comes out from the vicinity of the wand to clean the wand. → To clean the wand with it extended, perform "Wand cleaning".	28
The wand extends but the cleansing water does not come out / The cleansing water pressure is weak	● Has a water failure occurred? → ■ Press "Stopping" button on the remote control and wait until water service is restored.	-
	● Is the shutoff valve closed? → Fully open the shutoff valve.	15
	● Is the water filter drain valve clogged with foreign matter? → Clean the filter.	29
The cleansing water is cold	● Is the water pressure set to a low level?	16
	● Is the warm water temperature set to "OFF" or a low level? ● When the temperature of the water supply or the bathroom is low, the water temperature may be low when first sprayed.	20
Stops in the middle of use	● "Rear cleansing", "Rear soft cleansing" and "Front cleansing" stop automatically after 5 minutes of continuous use.	-
	● Does the seat switch have difficulty detecting? → Sit back on the toilet seat. If you get up slightly from the seat, or sit forward on the seat, the seating switch may temporarily stop detecting your presence.	11
Water comes out unexpectedly from the wand	● Water comes out from the area around the wand for several seconds after the Pre-mist has finished.	-
	● Is the "Wand CLEAN" LED on the main display flashing? ● "Auto Wand CLEAN" starts and the wand is cleaned.	19

Flushing*1

Trouble	Please check	Ref. Page
For not flushing	● Are the main tap and the in-wall tank's shutoff valve fully open?	-
	● Has a water failure occurred? → Use a bucket to flush water.	36
The toilet does not flush even when the button is pressed	● Are you pressing the button repeatedly? (After pressing the flush button, operation will not be accepted for about 10 to 20 seconds.)	-
The bowl unit does not clean automatically or timing is delayed (Auto flushing)	● Is "Auto flushing" set to "OFF"? → Set to "ON".	32
	● Even if "Auto flushing" is set to "ON", it is not available in the following instances. ● About 60 seconds after the toilet is flushed. → Wait about 60 seconds and flush the toilet with the remote control. ● When the time spent sitting on the toilet seat is less than about 6 seconds. → Flush with the remote control. ● When standing and using. → Flush with the remote control.	17
	● The seat switch will not turn on unless you sit on the seat properly. → Sit back on the toilet seat.	17
	● The timing for the "Auto flushing" can be changed. (After about 10 seconds → after about 5 or 15 seconds)	17
	● The seat switch will not turn on unless you sit on the seat properly. → Sit back on the toilet seat.	11
The toilet flushes on its own	● Is "Auto flushing" set to "ON"? → You can turn it "OFF".	32
	● Does the seat switch have difficulty detecting? → Sit back on the toilet seat. If you lift your hip off the toilet seat during use or sit forward on it, the seat switch may not turn on, and thus auto flushing may occur during use.	11

Toilet Seat and Toilet Lid

Trouble	Please check	Ref. Page
The toilet seat is cold	● Is the toilet seat temperature set to "OFF" or a low level?	20
	● Is energy saver in operation? ● The energy saver feature is on when the "Energy saver" LED is on and the "Power" LED is off on the main display. When you sit on the seat, the toilet seat heater is turned on temporarily and the seat is warmed in about 15 minutes. → You can turn it "OFF" if the energy saver feature is "ON".	22
	● Have you been seated for a long time? ● After about 20 minutes of sitting, the temperature starts going down, and after about 1 hour, the toilet seat heater is turned "OFF". → Stand up from the seat and then use again.	24
	● Is a toilet lid or seat cover installed? → Remove any covers.	-
		11

*1 Except SW4047T60 and SW4049T60.

Troubleshooting

Energy Saver

Trouble	Please check	Ref. Page
The Energy saver LED does not light up	<ul style="list-style-type: none"> ● Did you flip the power switch to OFF, or was there a power outage? <ul style="list-style-type: none"> • The "Energy saver" LED on the main display may go off when the power is turned on even if the energy saver feature is "ON". (It will turn on within about 24 hours since the setting is retained.) 	-
The timer energy saver feature is not working	<ul style="list-style-type: none"> ● Did you replace the remote control batteries? <ul style="list-style-type: none"> • "Timer energy saver" may be canceled when the batteries are replaced. →Set the timer energy saver again at the time you want to start it. 	24
The auto energy saver+ or auto energy saver feature is not working	<ul style="list-style-type: none"> ● Because the function takes several days learning the usage conditions before starting energy saver, the amount of energy saving may be low, depending on the frequency of use. →Check the energy saver setting. 	22

Deodorizer

Trouble	Please check	Ref. Page
The deodorizer seems to be not working	<ul style="list-style-type: none"> ● Is "Deodorizer" set to "OFF"? <ul style="list-style-type: none"> →Set to "ON". ● Even after sitting down, you do not hear operation sounds. <ul style="list-style-type: none"> →Sit back on the toilet seat. If you hear an operation sound from the deodorizer, but odors are not removed. <ul style="list-style-type: none"> →Clean the deodorizing filter. 	34 11 28
A strange odor is emitted	<ul style="list-style-type: none"> ● Are you using an air freshener or deodorizer that you purchased separately? <ul style="list-style-type: none"> • Doing so may reduce the effectiveness of the product's deodorizer or cause strange odors. →Remove the air freshener or deodorizer. 	-
The auto power deodorizer feature is not working	<ul style="list-style-type: none"> ● Is "Auto power deodorizer" set to "OFF"? <ul style="list-style-type: none"> →Set to "ON". ● It starts about 10 seconds after you stand up from the toilet seat. 	34 -

Sanitary

Trouble	Please check	Ref. Page
The Wand CLEAN LED does not light up	<ul style="list-style-type: none"> ● If the "Wand CLEAN" LED does not light up, it is time to replace the component that generates "ewater+". Consult the installer, seller, or TOTO customer service (see contact information on the back cover). 	-

Others

Trouble	Please check	Ref. Page
Water is leaking from the plumbing connections	<ul style="list-style-type: none"> ● If any nuts in a connection are loose, firmly tighten them with a tool such as a monkey wrench. →If the water leak does not stop, close the shutoff valve and consult with TOTO customer service (see contact information on the back cover). 	-
The main unit is unstable	<ul style="list-style-type: none"> ● There is clearance between the toilet seat cushion and the bowl unit for activating the seat switch. When you sit on the toilet seat, the toilet seat subsides slightly to activate the seat switch. 	11
The main unit makes a sound	When sitting on the toilet seat	
	<ul style="list-style-type: none"> ● When "Pre-mist" is "ON", you hear operation sounds for preparing the pre-mist or spraying mist in the bowl unit. →You can turn it "OFF". 	18 32
	When moving away from the bowl unit after use	
	<ul style="list-style-type: none"> ● When "Auto power deodorizer" is "ON", operation sounds are made while the deodorizing power increases for 60 seconds after you stand up from the toilet seat. →You can turn it "OFF". 	18 34
	<ul style="list-style-type: none"> ● If "Auto wand CLEAN" is "ON" and you use the cleansing functions (e.g.,Rear cleansing and Front cleansing), you may hear that the wand is extended and cleaned with "ewater+". →You can turn it "OFF". 	18 32
	<ul style="list-style-type: none"> ● You may hear the fan ventilating the unit. (About 30 minutes) 	-
You feel air in the toilet bowl when sitting on the toilet seat	When not using the product (e.g., at night)	
	<ul style="list-style-type: none"> ● If "Auto wand CLEAN" is "ON" and you do not use the cleansing functions (e.g.,Rear cleansing and Front cleansing) for about 8 hours, you will hear that the wand is cleaned with "ewater+" and then the remaining water is drained from inside the product. →You can turn it "OFF". 	32
	<ul style="list-style-type: none"> ● A mist is sprayed inside the toilet bowl to make it more difficult for dirt to adhere when sitting on the toilet seat. You may feel air when a mist is sprayed. →You can turn it "OFF". 	18 32

