

TOTO

TOTO U.S.A., Inc. 1155 Southern Road Morrow, GA 30260
Phone : (770) 282 8686

Warranty Registration and Inquiry

For product warranty registration, TOTO U.S.A. Inc. recommends On-Line Warranty Registration. Please visit our web site <http://www.totousa.com>. If you have questions regarding warranty policy or coverage, please contact TOTO U.S.A. Inc., Customer Service Department, 1155 Southern Road, Morrow, GA 30260 (888) 295 - 8134 or (678) 466 - 1300 when calling from outside of U.S.A.

- You are advised to record the following information to allow quick service.

Date of purchase :	Name of shop :
Date : year month day	Tel : ()

2020.10.5
D07B51

TOTO

Instruction Manual

WASHLET

washlet

SW2033R
SW2014

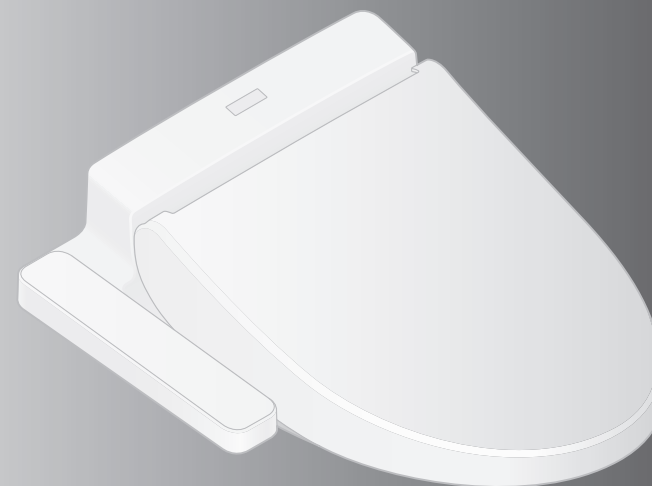

- Thank you for your recent purchase of the product.
Please read the enclosed information to ensure the safe use of your product.
- Be sure to read this Instruction Manual before using your product and keep it in a safe place for future reference.

The available functions vary according to the model.

Check your model name and write a check mark in this field as needed.

Functions		Product name (Model)	WASHLET		Ref. Page
		Part No.	SW2033R	SW2014	
		Your Model			
Basic Functions	Cleansing	Rear cleansing	●	●	15
		Rear soft cleansing	●	●	
		Front cleansing	●	●	
	Changing the washing method	Wand position adjustment	●	●	
		Water pressure adjustment	●	●	
		Oscillating cleansing	●	●	
	Drying	Warm air drying	●	—	
Changing the temperature	Temperature adjustment	●	●	18, 19	
Sanitary Functions	Removing odors	Deodorizer	●	—	16, 17
	Bowl pre-cleaning	Pre-mist	●	—	
Convenient Functions	Heating the toilet seat	Heated seat	●	●	—
	Saving energy	Energy saver	●	●	20, 21
Maintenance		Main Unit One-touch removal	●	●	26
		Removable toilet lid	●	●	27
		Wand cleaning	●	●	28



The self-cleaning functions operate automatically. (See pages 16 and 17 for details.)

	As you sit	As you stand up
Removing odors inside the toilet bowl.	Deodorizer	
A mist is sprayed inside the toilet bowl to make it more difficult for dirt to adhere.	Pre-mist	

Table of Contents



Safety Precautions	4	Introduction
Operational Precautions.....	11	
Parts Names	12	
Preparation.....	14	Operation
Basic Operations	15	
Automatic Functions.....	16	
DEODORIZER, PRE-MIST		
Temperature Adjustment.....	18	Maintenance
Energy Saver Feature	20	
Power Plug	24	
Main unit.....	25	
Deodorizing Filter	25	Reference
Gap between the Main Unit and the Toilet Bowl	26	
Gap between the Main Unit and the Toilet Lid	27	
Wand	28	
Wand cleaning		
Water Filter Drain Valve.....	29	
Changing Settings	30	
What to Do?.....	34	
● Freeze Damage Prevention...	34	
● Long Periods of Disuse	35	
Troubleshooting	36	
Specifications	40	
Warranty	41	

Safety Precautions



IMPORTANT SAFEGUARDS

READ ALL INSTRUCTIONS BEFORE USING

Symbols and Meanings

	WARNING	May result in death or serious injury.
	CAUTION	May result in injury or property damage.

The following symbols are used to indicate important safety instructions for the use of the product.

Symbol	Meaning
	This symbol indicates a prohibited use of the product.
	This symbol is used to indicate a required step in the use of this product.

WARNING

	Do not plug or unplug the power plug with wet hands.
	• Doing so may cause electrical shock.
	Do not get any water or cleaning solution on the main unit or power plug.
	• Doing so may cause fire, electrical shock, heat or short circuit.
	• Doing so may cause the product to crack resulting in injury or water damage.
Never disassemble, repair or alter.	
• Doing so may cause fire, electrical shock, overheating, short circuit or breakdown.	
Do not install the product on moving vehicles such as wheeled vehicles or boats.	
• Doing so may cause fire, electric shock, short circuit or malfunction.	
• The toilet seat, toilet lid, main unit or other parts may come loose and fall off, resulting in injury.	

WARNING

Do not use the product if a malfunction occurs.

- In case of breakdown or other problem, be sure to cut off power by means such as unplugging the power plug.

Close the water shutoff valve to stop water supply.

Possible malfunctions:

- Water is leaking from a pipe or the main unit.
- The product is cracked or broken.
- The product makes a strange noise or emits a strange odor.
- The product emits smoke.
- The product is abnormally hot.
- The toilet seat cushion is out of place.

- Continued use after malfunction could cause a fire, electric shock, heat, short circuit, injury or water damage.

Do not use other water than allowed by the laws and ordinances of the region of use. Only use drinking water.

Do not use seawater or recycled water.

- Doing so may cause irritation to the skin and malfunction.

Do not touch the power plug during thunderstorms.

- Doing so may cause electrical shock.



Do not allow the water supply hose to touch the power plug or outlet.

- Doing so may cause condensation resulting in a fire, electrical shock, heat or a short.

Do not do anything that may damage the power cord, power plug.

Do not strike, yank, twist, excessively bend, damage, alter, or heat the power cords. Also, do not place anything heavy on, bind or pinch the power cords.

- Using a damaged power cord may result in a fire, electrical shock, heat or short.

Do not use a loose or faulty electrical outlet.

- Doing so may cause fire or short circuit.

Do not use any outlet or wiring equipment beyond its specified rating.

- Plugging too many plugs into the same outlet, for example using outlet splitters, can cause fire due to heat.

Do not use any power supply other than the one specified.

AC 120 V, 60 Hz

- Doing so may cause fire or excessive heat.

Do not stick a finger or anything else into the warm air outlet.*

Do not place anything on the warm air outlet or drape clothes over it.

- Doing so may cause burns, electrical shock or malfunction.

Keep cigarettes and other open flames away from the product.

- Failure to do so may cause fire.

* Except SW2014

Safety Precautions (Continued)

WARNING

Refrain from sitting on the seat for long periods.

- It may cause low-temperature burns.
To prevent the following persons from getting a moderate temperature burn during use, other person should turn off the toilet seat heater and set the dryer temperature to "Low".
 - Young children, the aged and other users unable to set the temperature appropriately themselves.
 - The ill, physically disabled and others who do not have freedom of movement.
 - Those using any medicines that cause drowsiness (sleeping or cold medicine), those who have been drinking heavily, anyone severely fatigued and anyone else liable to fall asleep.

This is an electrical product. Do not install it anywhere water is likely to get on the product or anywhere with humidity high enough that water is likely to form on the surface of this product. When using the product in a bathroom, install a fan or ventilation port and ensure good air flow through the bathroom.

- Failure to do so may cause fire or electrical shock.

Always connect the product to the cold water supply.

- Connecting to hot water supply may result in burns and equipment damage.

Make sure that a properly grounded (3 prong) outlet has been installed.

- Failure to install a grounded outlet could cause electrical shock in the event of a malfunction or short circuit.

Insert the power plug securely into the outlet.

- Failure to do so may cause fire, heat or short circuit.

To unplug, hold the power plug, not the power cord.

Do not unplug by pulling the power cord.

- Pulling on the power cord may cause damage and result in fire or heat.

If the power cord is damaged, avoid danger by having the manufacturer's repair department or equivalent specialist replace it.

Always unplug the power plug from the outlet before maintenance or inspection.

- Failure to do so may cause electrical shock or malfunction.
* Except when using "Wand cleaning".

Periodically remove dust and dirt from the power plug and make sure it is securely plugged into the wall outlet.

- Failure to do so may cause fire, heat or short circuit.
Pull the power plug out from the outlet and wipe clean with a dry cloth.

Always unplug the power plug from the outlet before removing the main unit.

- Failure to do so could cause a fire or electrical shock.



WARNING

Preliminary studies in females suggest that overuse of continuous spraying can increase the possibility of vaginal mucosa drying and potential reduction in desirable microbial organisms.

Although these studies have not been validated, please consult your healthcare provider for concerns regarding whether these circumstances may apply to you.

More importantly, if you are an individual suffering from any immune deficiency as a result of disease, chemotherapy, or other medical condition compromising the immune system you should consult your healthcare provider before use of this product.



CAUTION

Do not use the product if the main unit is unstable.

- Doing so may cause the main unit to come loose and fall, resulting in injury.

If the product is damaged, do not touch the damaged section.

- Doing so may cause electrical shock or injury.
Replace it immediately.

Do not apply strong force, mechanical shock, step on or stand on the toilet seat, toilet lid or main unit. Also do not place any heavy object on the toilet seat, toilet lid or main unit.

- Doing so may cause cracking or cause the main unit to come loose and fall, resulting in injury.
- Doing so could damage the product and cause injury or water damage.

Do not lift up this product by the toilet seat or lid.

Do not raise the toilet seat or lid while objects are resting on top of the unit.

- Doing so may cause the main unit to come loose and fall, resulting in injury.

When maintaining the plastic parts (main unit etc.) or the water supply hose, use a neutral kitchen detergent diluted with water. Do not use any of the following.

Toilet cleaner, household cleaner, benzene, paint thinner, powdered cleanser or nylon scrubbing pads.

- These items may damage or crack the plastic and cause injury or malfunction.
- These items could damage the water supply hose and cause a water leak.



Safety Precautions (Continued)

CAUTION



To prevent a sudden water leak, do not remove the water filter drain valve when the shutoff valve is open.

- Doing so will cause water to spurt out.
(Refer to Page 29 for instructions on cleaning the water filter drain valve.)

Do not fold or crush the water supply hose; do not damage by cutting with a sharp object.

- Doing so may cause water leaks.

Do not install the base plate, which is not attached.

- Doing so may cause damage.

If a water leak should occur, always close the shutoff valve.

When the ambient temperature is likely to drop to 0°C (32°F) or lower, prevent damage to the pipes and hoses due to freezing.

- Frozen water pipes could cause the main unit and the pipes to break, resulting in a water leak.
- Regulate the room temperature to prevent the pipes and hoses from freezing during cold months.
- Drain the water.

When not using the product over an extended period of time, drain the water out of the top unit and the water supply hose after closing the water shutoff valve, and pull the power plug from the outlet.

- When using the product again, allow the product to refill with water first. Otherwise, the water in the tank might become contaminated and cause skin inflammation or other problems. (Refer to Page 35 for instructions on replenishing the water.)
- Leaving the power on may cause fire or heat.



When installing the water filter drain valve, make sure that it is securely tightened in its proper position.

- Failure to securely tighten it may cause a water leak.

Push the main unit securely on to the base plate.

- After pushing the main unit until a click sound is heard, pull it slightly toward you to make sure that the product does not detach.
- Failure to do so could cause the main unit to come loose and fall resulting in injury.

DANGER To reduce the risk of electrocution:

1. Do not use while bathing.
2. Do not place or store the product where it can fall or be pulled into a tub or sink.
3. Do not place in or drop into water or other liquid.
4. Do not reach for the product when it has fallen into water. Unplug immediately.

WARNING To reduce the risk of burns, electrocution, fire or injury to persons:

1. Close supervision is necessary when this product is used by, on, or near children or invalids.
2. Use this product only for its intended use as described in this manual. Do not use attachments not recommended by the manufacturer.
3. Never operate this product if it has a damaged cord or plug, is not working properly, has been dropped or damaged, or has been dropped in water. Return the product to a service center for examination and repair.
4. Keep the cord away from heated surfaces.
5. Never block the air openings on the product or place it on a soft surface, such as a bed or couch, where the air openings may be blocked. Keep the air openings free of lint, hair, and other similar items.
6. Never use while sleepy or drowsy.
7. Never drop or insert any object into any opening or hose.
8. Do not use outdoors. Do not operate where aerosol (spray) products are being used or where oxygen is being administered.
9. Connect this product to a properly grounded outlet only.
See "Grounding Instructions" in Page 10.
10. The tank should be filled with water only.

- Servicing should be performed by an authorized service representative.
- This product is for household use.

Safety Precautions (Continued)

Grounding Instructions

This product should be grounded. In the event of an electrical short circuit, grounding reduces the risk of electric shock by providing an escape wire for the electrical current.

This product is equipped with a cord having a grounding wire with a grounding plug.

The plug must be plugged into an outlet that is properly installed and grounded.

⚠ DANGER - Improper use of the grounding plug can result in a risk of electric shock.

If repair or replacement of the cord or plug is necessary, do not connect the grounding wire to either flat-head terminal.

Check with a qualified electrician or serviceman if the grounding wire instructions are not completely understood, or if in doubt as to whether the product is properly grounded.

SAVE THESE INSTRUCTIONS

Operational Precautions

■ For prevention of malfunctions

< About the seat switch >

- When you sit on the toilet seat, the seat switch turns ON, enabling you to use various features.
(A click sound is heard when the seat switch is ACTIVATED.)

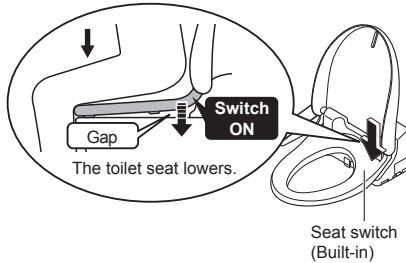

- Sit back on the toilet seat.
 - The seat switch will not turn on unless you sit on the seat properly.



Note

- When a child uses the Washlet, the seat switch may not be ACTIVATED by their light body weight.
- Since the toilet seat is designed to move up and down, a clearance is provided between the toilet seat cushion and the toilet bowl.

■ For prevention of damage

- Wipe plastic areas such as the main unit and control panel with a soft cloth tightly wrung out with water.
- Do not lean against the toilet lid.



■ Problem Prevention

- Disconnect the power plug if there is a risk of lightning.
- A toilet seat cover or a toilet lid cover cannot be used.
(The seat switch may not function properly.)



- Do not urinate on the main unit, toilet seat or wand.
(Doing so may cause a failure or discoloration.)
- Do not apply strong forces to the control panel.
- When using a toilet cleaner to clean the toilet, wash it off within 3 minutes and leave the toilet seat and toilet lid open. Wipe off any cleaner that remains on the toilet bowl.
(If vapor from a toilet bowl cleaner enters the main unit, it may cause a malfunction.)
- Do not use the product with the toilet lid removed.
- Do not expose to direct sunlight.
(Doing so may cause changes in color, irregular heated seat temperature, the control panel malfunction or Washlet malfunction due to the change in temperature.)
- Use radios, etc. away from the Washlet.
(The Washlet could cause interference with the radio signal.)
- If you use a booster seat for infants or a soft highchair, remove it after use.
(Keeping it installed may prevent some of the functions from being used.)
- Do not place anything on the toilet seat and lid, and do not press them with hands.
Failure to do so may turn on the seat switch, causing the floor to get wet if buttons on the control panel are touched and warm water comes out from the wand. (The seat switch may turn on if force is applied to the toilet seat or lid.)

Parts Names

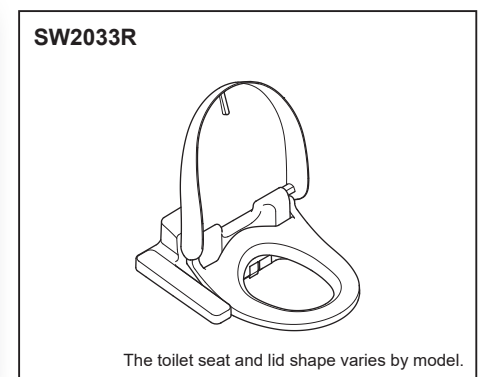
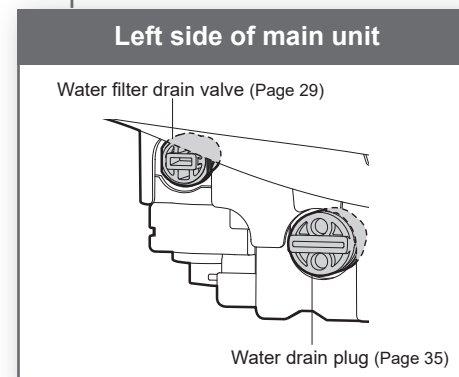
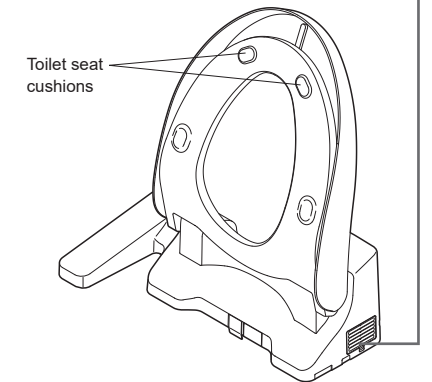
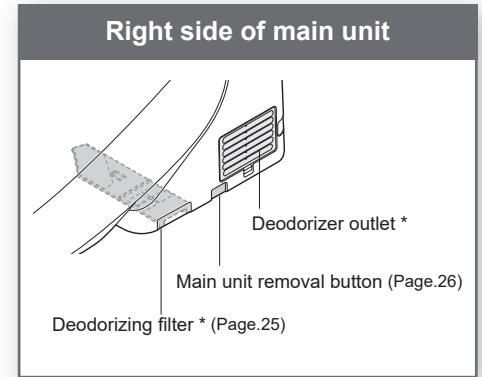
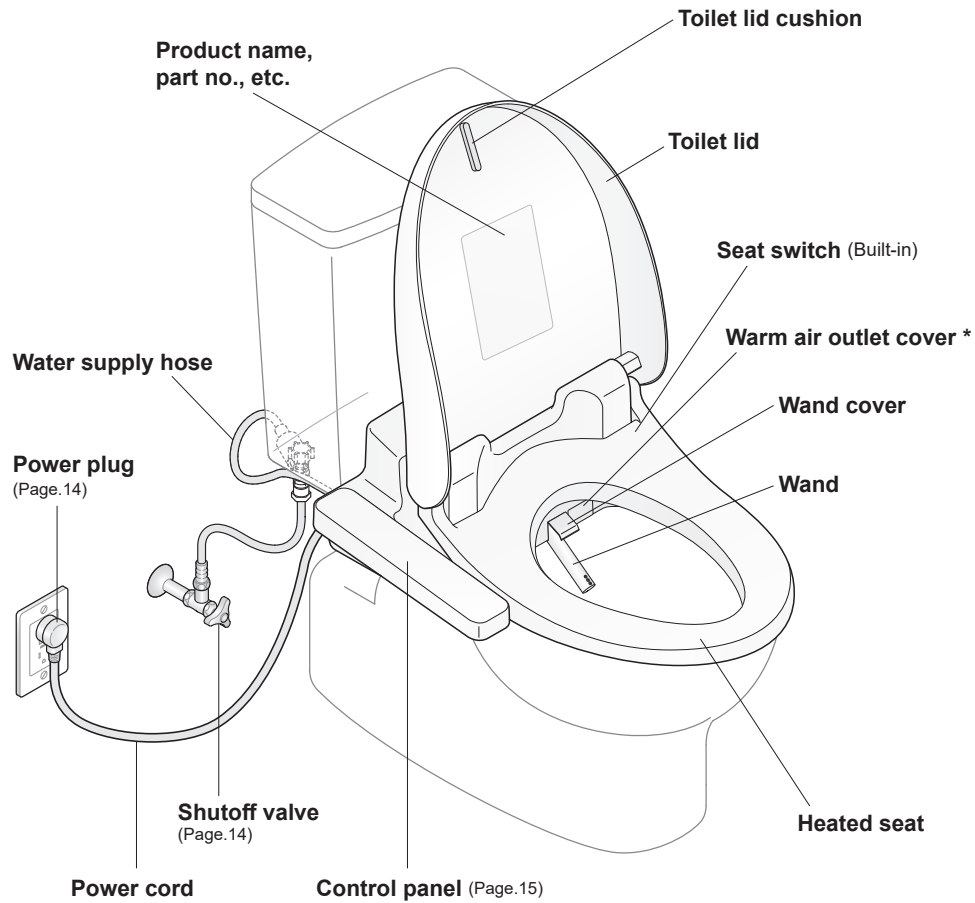

* Except SW2014

Descriptions in this manual are based on the illustrations of SW2014.

Preparation

Using the Product for the First Time

1. Turn on the power

- 1** Insert the power plug.
 • The wand extends and then retracts.

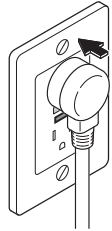

- 2** Check that the POWER LED on the main display is lit up.

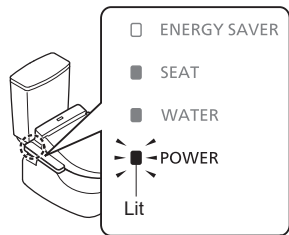

2. Open the shutoff valve

- 1** Fully open the shutoff valve.

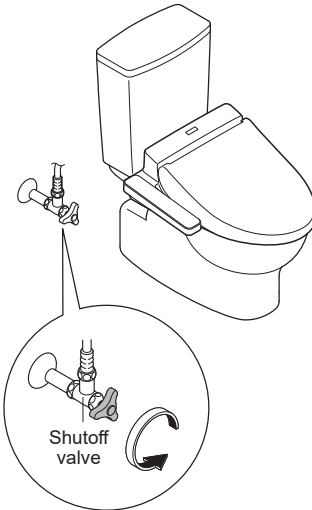

Basic Operations

Cleansing

[REAR] Cleanses your rear.

[SOFT REAR] Washes your rear with mild water pressure.

[FRONT] Serves as a bidet for ladies.

[OSCILLATING] When you press this button again during use, the wand moves back and forth to wash your rear thoroughly.

Drying

[DRYER]* Dries your rear.

Stopping **[STOP]**

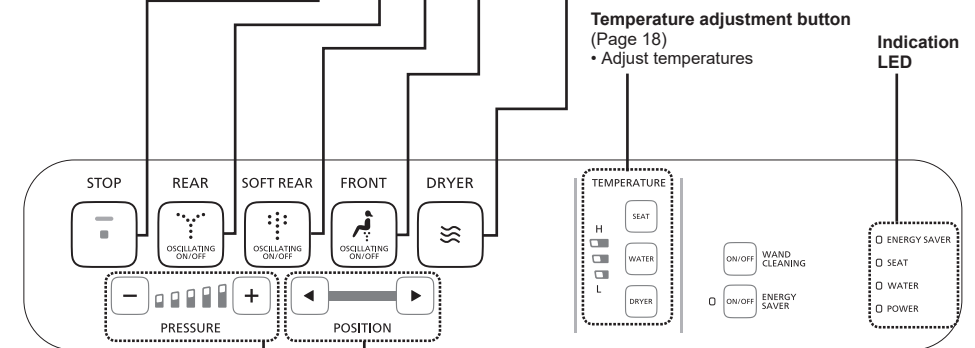

● Functions that operate when a button is pressed during "REAR", "SOFT REAR" or "FRONT" cleansing.

[PRESSURE]

- You can adjust the water pressure as desired to 5 different levels.
- The PRESSURE LEDs lights up when you sit on the toilet seat.

[POSITION]

- You can adjust the washing position as desired to 5 different points.
- The washing position returns to the standard position (3rd point) when you stand up from the toilet seat.

Note

- Sitting back on the toilet seat makes it easier to adjust the wand position and to reduce splashing.

* Except SW2014

For your information

- Water may sometimes come out from around the wand when it expands in the warm water tank, but this is normal.
- As the warm water tank of hot-water system is used, the temperature of warm water may become lower if it is continuously consumed.

Automatic Functions

Cleaning Features

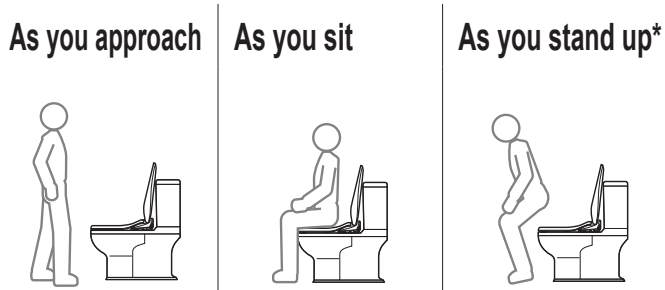

Note

Changing settings

<p>Removing odors inside the toilet bowl</p> <p>DEODORIZER (SW2033R only)</p>		 <p>Starts the deodorizer</p>	<p>Deodorizer stops →It stops after about 2 minutes</p>	<ul style="list-style-type: none"> • DEODORIZER ON/OFF (Page 32)
------------------------------------------------------------------------------------------	--	----------------------------------------------------------------------------------------------------------------	--------------------------------------------------------------------	---------------------------------------------------------------------------------

<p>A mist is sprayed inside the toilet bowl to make it more difficult for dirt to adhere</p> <p>PRE-MIST (SW2033R only)</p>		 <p>A mist is sprayed inside the toilet bowl</p>	<ul style="list-style-type: none"> • The pre-mist will not spray for about 90 seconds after you stand up from the toilet seat. 	<ul style="list-style-type: none"> • PRE-MIST ON/OFF (Page 32)
----------------------------------------------------------------------------------------------------------------------------------------	--	------------------------------------------------------------------------------------------------------------------------------------	-----------------------------------------------------------------------------------------------------------------------------------------------	-------------------------------------------------------------------------------

* To clean the toilet bowl every time it is used, water remaining in the wand is drained after you stand up from the toilet seat.

Temperature Adjustment Warm Water / Toilet Seat / Drying *

Three different temperature levels (high / medium / low) and "OFF" setting can be made.

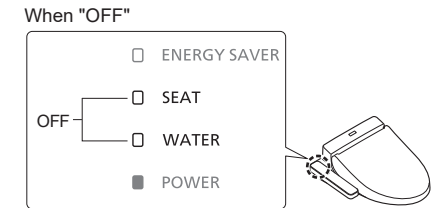
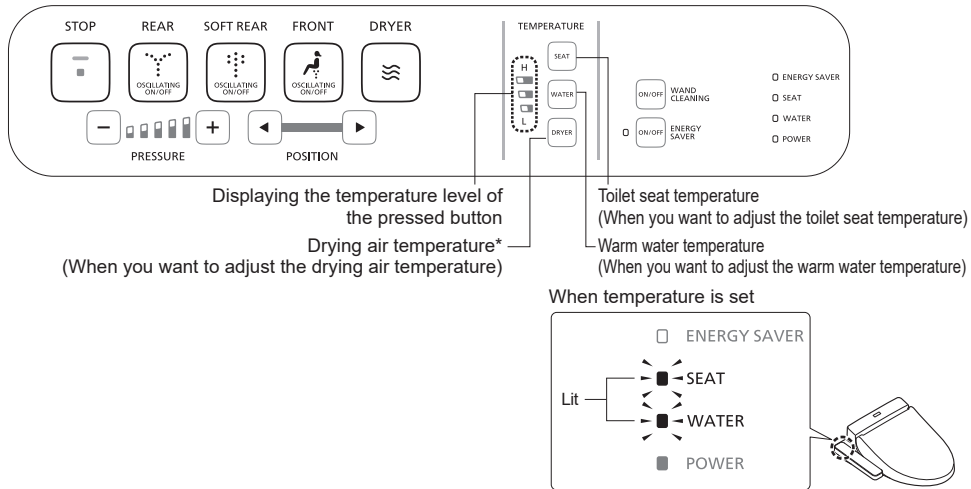

Adjusting the temperature

1 Select a temperature button you want to set from



• The current temperature level appears.

2 Press the button selected in step 1 repeatedly until a desired temperature level lights up.

The setting changes each time the button is pressed once

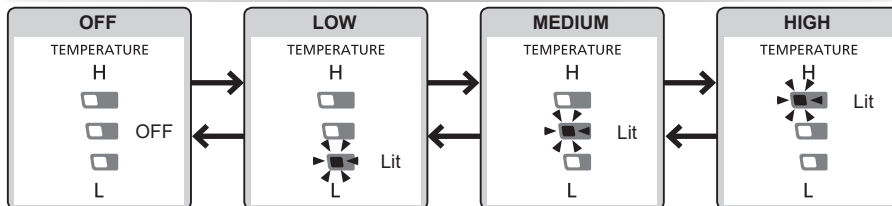

The "DRYER" cannot be turned "OFF".

<Setting complete>

Note

- If the button is not pressed for about 10 seconds, the temperature adjustment LED will go off, but the setting will be retained.
If the temperature adjustment LED goes out before the setting is completed, start all over again at step 1.
- When the toilet seat does not get warm, or when the warm water is not warm enough, even after temperature adjustment.
→ Is the energy saver set to "ON"? (Page 20)

To turn the warm water temperature and toilet seat temperature "OFF"

*The "DRYER" cannot be turned "OFF".

1 Select a temperature button you want to turn "OFF" from



• The current temperature level appears.

2 Press the button selected in step 1 repeatedly until the temperature level is set to "OFF".
When "OFF" is set, the LED will go off.

The setting changes each time the button is pressed once

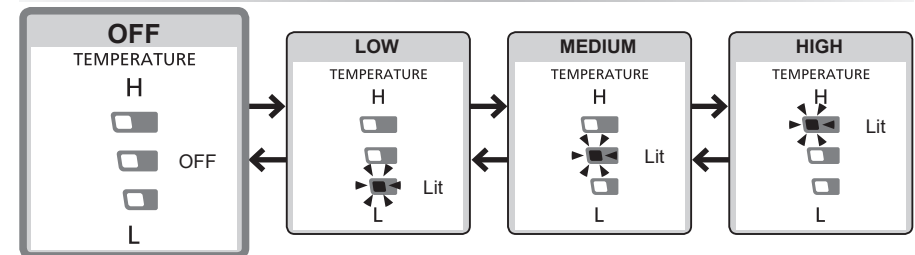





<Setting complete>

Energy Saver Feature

You can save energy by turning the toilet seat heater to a low temperature (or turning the heater "OFF") during periods when the toilet will be used infrequently.

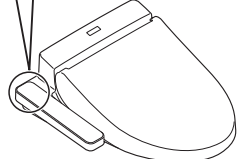
When the energy saver feature is "OFF", the temperature is kept at the same level.

- It takes about 10 days for the product to determine the periods when it is used relatively less frequently.

Situation	When energy saver is set	When energy saver is in operation		AM		PM				
	Main Display		Toilet seat heater	Warm water heater	0	6	8	5	9	0
<p>ENERGY SAVER</p> <p>You want the Washlet to save energy automatically</p> <p>The Washlet detects time periods with infrequent use and lowers the toilet seat temperature automatically. Furthermore, it automatically turns off the toilet seat and warm water heater during time periods when the toilet is never used.</p>	<p>Lit (Green) — ENERGY SAVER</p> <p>SEAT</p> <p>WATER</p> <p>POWER</p> 	<p>Time period with infrequent use</p> <p>Lit (Orange) — ENERGY SAVER</p> <p>SEAT</p> <p>WATER</p> <p>OFF — POWER</p>	<p>Low</p> 	<p>Set temperature^{*1}</p> 	<p>Example) Time period with infrequent use (from 9:00PM to 6:00AM): Low</p> <p>Time period the toilet is never used (8:00AM to 5:00PM): OFF</p>	<p>Low temperature^{*2}</p>	<p>Set temperature^{*1}</p>	<p>Set temperature^{*1}</p>	<p>Low temperature^{*2}</p>	<p>Low temperature^{*2}</p>
	<p>When energy saver is not set</p> <p>OFF — ENERGY SAVER</p> <p>SEAT</p> <p>WATER</p> <p>POWER</p>	<p>Time period the toilet is never used</p> <p>Lit (Orange) — ENERGY SAVER</p> <p>SEAT</p> <p>WATER</p> <p>OFF — POWER</p>	<p>OFF</p> 	<p>OFF</p> 	<p>OFF^{*3}</p>					

Note

- Even if the ENERGY SAVER is being activated (with the toilet seat heater set to "Low" or "OFF," or with the warm water heater set to "OFF"), the toilet seat will be temporarily heated when you sit on it. (To reach the setting temperature, the toilet seat takes about 15 minutes and the warm water about 10 minutes, respectively.)

*1 The temperature set on Page 18.

*2 The time period when the toilet seat heater is set to a "Low". The warm water heater is "Set temperature".

*3 The time period when the toilet seat heater and warm water heater are "OFF".

To set energy saver Page 22 · 23

Energy Saver Feature

How to set

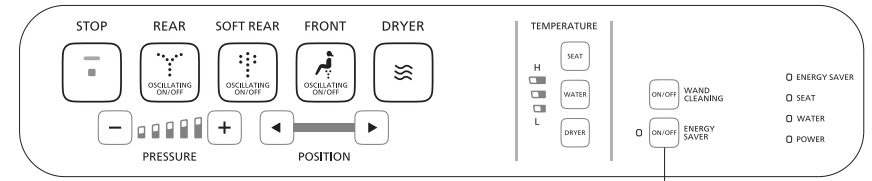

Energy-saver setting button

ENERGY SAVER

1 Press .

The setting changes each time the button is pressed once

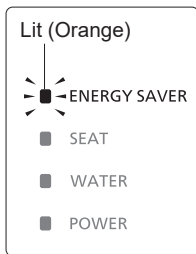
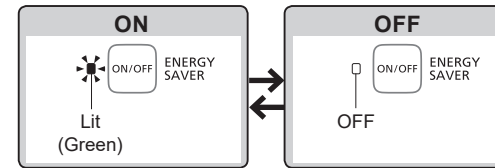

The ENERGY SAVER LED will be lit if the energy saver feature is working.
ENERGY SAVER : Lit (Orange)

Maintenance

Power plug

(Approximately once a month)



Dry cloth



Wet cloth

- 1 Disconnect the power plug and wipe it with a dry cloth.

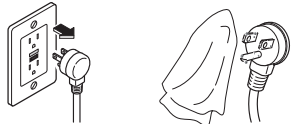

- 2 Insert the power plug.
 - The POWER LED lights up.

WARNING

- Periodically remove dust from the blades and other parts of the power plug.
 - Unplug the power plug and wipe it with a dry cloth.



- Fully insert the power plug.
- When unplug the power plug, hold the main body of the power plug.
 - Pulling the power cord may damage the power plug or power cord.

WARNING

- Always unplug the power plug from the outlet before maintenance or inspection. (Failure to do so may cause electric shock or malfunction, resulting in a breakdown.)

***For safety, disconnect the power plug before cleaning or maintenance.**

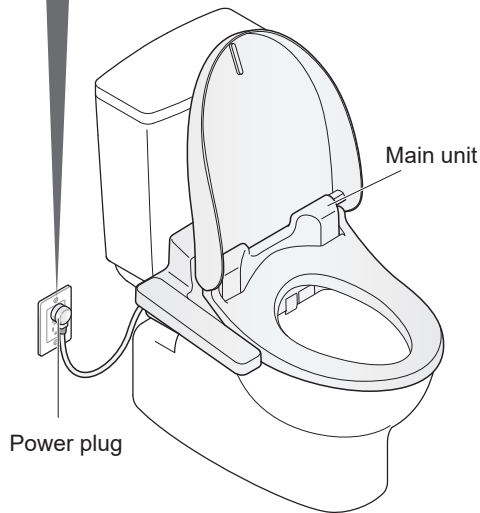

Do not use a dry cloth or toilet paper on plastic parts. (May cause damage.)



* Except when using "Wand cleaning".

Main Unit

(Approximately daily)



Soft cloth soaked in water



- Toilet paper
- Dry cloth
- Nylon scrubbing pads (May cause damage.)

- 1 Unplug the power plug.

- 2 Wipe with a soft cloth that has been soaked in water and wrung-out thoroughly.

For heavy dirt

- Wipe with a soft cloth soaked in diluted, neutral kitchen detergent, and then wipe with a soft cloth soaked in water.



• Neutral kitchen detergent



- Paint thinner
- Benzene
- Powdered cleanser

- 3 Insert the power plug.
 - The POWER LED lights up.

Attention!

- The Washlet is an electric appliance. Be careful not to let water seep inside or leave detergent in the gap between the main unit and toilet bowl. (May damage plastic parts or cause a malfunction.)
- When using a toilet cleaner to clean the toilet, wash it off within 3 minutes and leave the toilet seat and toilet lid open.
 - Wipe off any cleaner that remains on the toilet bowl. (If vapor from a toilet bowl cleaner enters the main unit, it may cause a malfunction.)
- Do not push or pull the covers around the wand with undue force. (May cause damage or malfunction.)
- Wipe the back surface of the toilet seat and the toilet seat cushions with a soft cloth tightly wrung out with water. (Otherwise adhesion of dirt may result in discoloration.)

Deodorizing filter

(Approximately once a month)
(SW2033R only)

- 1 Unplug the power plug.

- 2 Remove the deodorizing filter.
 - Hold the knob and pull outward.
 - Do not pull with undue force. (May cause damage or malfunctions)

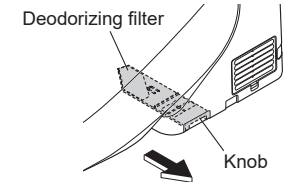

- 3 Clean with a tool such as a toothbrush.
 - When washing with water, dry off all water before mounting.

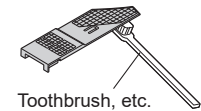

- 4 Mount the deodorizing filter.
 - Push firmly until a click sound is heard.

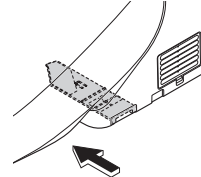

- 5 Insert the power plug.
 - The POWER LED lights up.

Maintenance

Gap between the Main Unit and Toilet Bowl (Approximately once a month)

You can remove the main unit to clean the top of the toilet bowl and the bottom of the main unit.



Soft cloth soaked in water



Toilet paper, etc. (May cause damage.)

- 1 Unplug the power plug.



If the power is not unplugged, the unit may malfunction or cause a failure or electric shock.

- 2 Remove the main unit.

- Do not pull the unit with undue force (because the water supply hose and power cord are attached).

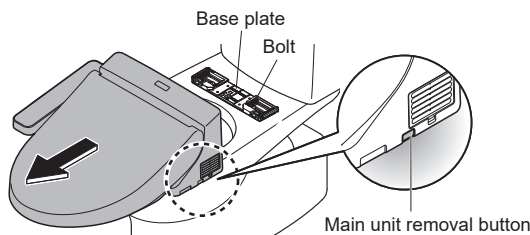

Pull the main unit toward you while pressing the button.

- 3 Clean the gap.

- Wipe with a soft cloth soaked in a diluted, neutral kitchen detergent. Then, wipe it with a soft cloth soaked in water so that no detergent remains.

- 4 Mount the main unit.

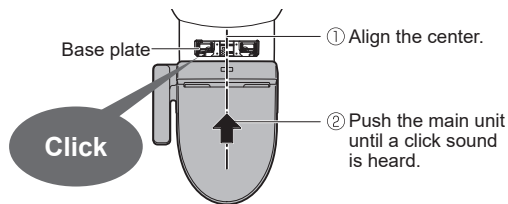

CAUTION

Push the main unit firmly on to the base plate until a click sound is heard.
(Failure to do so could cause the main unit to come loose and fall resulting in injury.)

After mounting, check that the main unit does not detach even when pulled.

- 5 Insert the power plug.

- The POWER LED lights up.

Gap between the Main Unit and the Toilet Lid (Approximately once a month)

The toilet lid can be removed for thorough cleaning.



Soft cloth soaked in water



Toilet paper, etc. (May cause damage.)

- 1 Unplug the power plug.



- 2 Remove the toilet lid.

A: Pull the left side outward.

B: Disconnect the hinge from the recess and pull up.

C: Disconnect the right side.

- 3 Wipe with a soft cloth that has been soaked in water and wrung-out thoroughly.

- 4 Reinstall the toilet lid.

D: Join the pin and the hinge on the right side.

Slightly tilt the toilet lid to the front.

A: While pulling out the left side,

E: Mount by joining the hinge with the recess.

* Be careful not to pinch your fingers.

- 5 Open and close the toilet lid to check the mounting, and then mount the main unit.

- 6 Insert the power plug.

- The POWER LED lights up.

Removing and Reinstalling

Hold with both hands

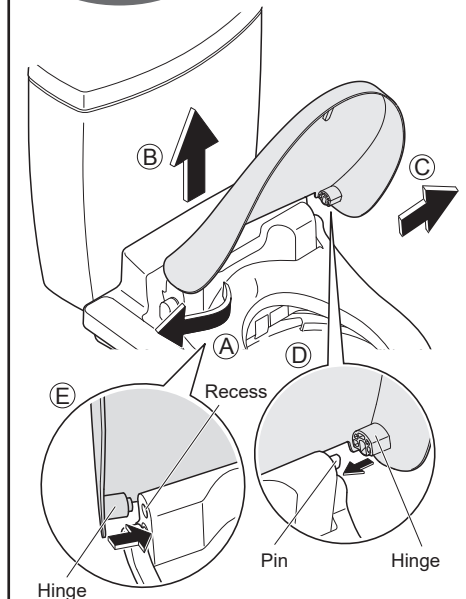

Maintenance

Wand (Approximately once a month) <If you notice dirt (Wand cleaning) >



Soft cloth soaked in water



Toilet paper, etc.
(May cause damage.)

- 1** Press .
- The wand extends and water sprays out for cleaning.
 - The wand automatically retracts after about 5 minutes.

- 2** Wipe with a soft, wet cloth.
- Do not pull, push or press the wand with excessive force. (May cause damage or malfunction.)

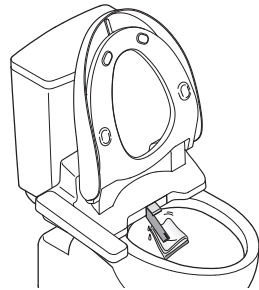

- 3** Press .
- The wand retracts.

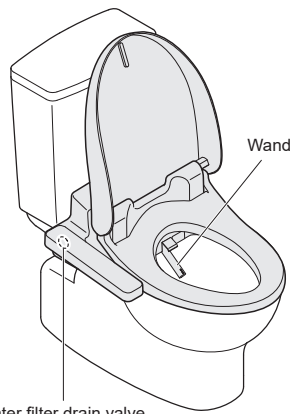
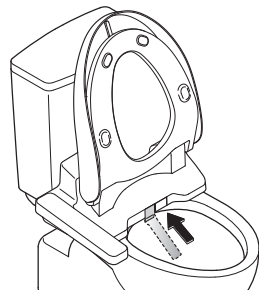

Water filter drain valve

Water filter drain valve (Approximately once every 6 months) <If you think the water pressure has weakened>

- 1** Close the shutoff valve.
- The water supply stops.

CAUTION

- Do not remove the water filter drain valve while the shutoff valve is open.
(Otherwise, water may leak out)

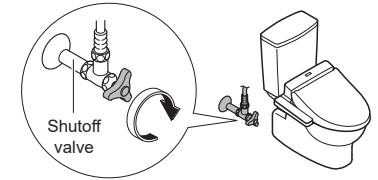

- 2** Press to extend the wand, and then press again to return the wand.
(Release the pressure from the water supply pipe.)

- 3** Unplug the power plug.

- 4** Remove the water filter drain valve.
- Loosen the water filter drain valve with a flat-head screwdriver and then pull it.

- 5** Clean with a tool such as a toothbrush.
- Also, remove any dust from inside the hole of the water filter drain valve.

- 6** Reinstall the water filter drain valve.
- Insert the water filter drain valve and tighten it securely with a flat-head screwdriver.

- 7** Insert the power plug.
- The POWER LED lights up.

- 8** Open the shutoff valve.

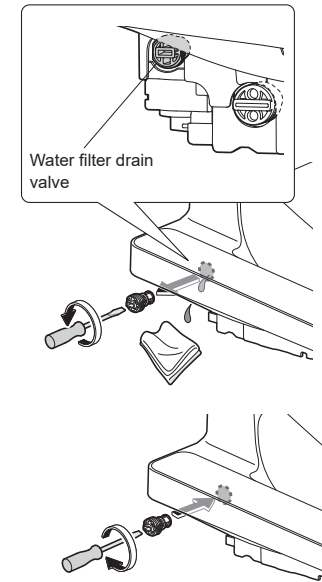

Changing Settings

Setting List

To change the settings, check that all LEDs on the control panel are flashing!

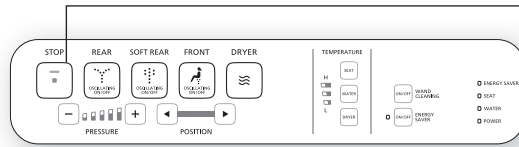

● Press about 10 seconds or longer
STOP



All LEDs on the control panel flash.

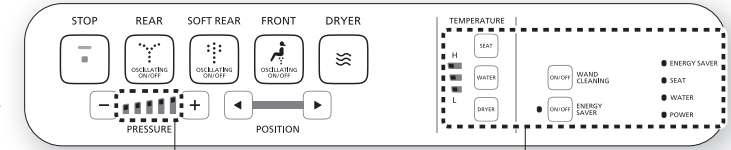

Settings cannot be changed unless all LEDs flash

Setting Types		Available Settings Bold: Initial settings	Applicable Models	Setting Ref. Page
AUTO FUNCTIONS	CLEANING	PRE-MIST	SW2033R	Page 32
		DEODORIZER		

Note

• If you do not press a next button within about 60 seconds after the LED flashes, the flashing LED will be disabled. If you fail to complete the setting, redo from the beginning.

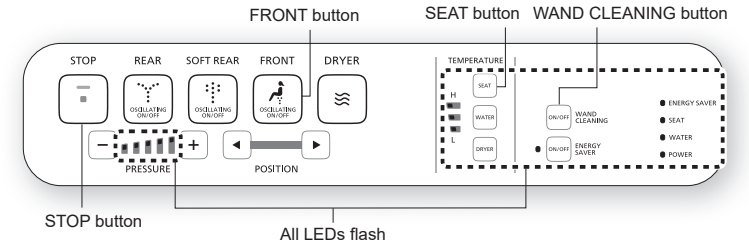

Changing Settings



CLEANING

1  Press until all LEDs on the control panel start flashing (about 10 seconds)

Set whether or not to spray mist in the toilet bowl automatically
PRE-MIST
(SW2033R only)

2 Press  and  at the same time. The setting changes each time the button is pressed once

ON	OFF
<input type="checkbox"/> ENERGY SAVER	<input type="checkbox"/> ENERGY SAVER
<input checked="" type="checkbox"/> SEAT	<input type="checkbox"/> SEAT
<input checked="" type="checkbox"/> WATER	<input type="checkbox"/> WATER
Flickering (Orange) <input checked="" type="checkbox"/> POWER	OFF <input type="checkbox"/> POWER

Set whether or not to deodorize automatically
DEODORIZER
(SW2033R only)

2 Press . The setting changes each time the button is pressed once

ON	OFF
<input type="checkbox"/> ENERGY SAVER	<input type="checkbox"/> ENERGY SAVER
<input checked="" type="checkbox"/> SEAT	<input type="checkbox"/> SEAT
<input checked="" type="checkbox"/> WATER	<input type="checkbox"/> WATER
Flickering (Green) <input checked="" type="checkbox"/> POWER	OFF <input type="checkbox"/> POWER

3 Press .
<Settings complete>

What to Do?

Freeze Damage Prevention

When the ambient temperature is likely to drop to 0°C (32°F) or lower, take measures to prevent freezing.

Attention!

- When the ambient temperature is likely to drop to 0°C (32°F) or lower, do not use the energy saver feature. (May damage the product.)
- Warm the bathroom or take measures against freezing so that the ambient temperature does not drop below 0°C (32°F).

How to freeze damage prevention

How to drain the water

- 1 Close the shutoff valve.
 - The water supply stops.

CAUTION

Do not remove the water filter drain valve while the shutoff valve is open.
(Otherwise, water may leak out)

- 2 Drain the water from the toilet tank.
 - Turn the flush handle of the toilet tank to the full flush side.
 - Turn the lever until water flow stops.



- 3 Drain the pipe.
 - (1) Press **ON/OFF WAND CLEANING** to extend the wand, and then press **ON/OFF WAND CLEANING** again to return the wand. (Release the pressure from the water supply pipe.)
 - (2) Unplug the power plug.
 - (3) Remove the water filter drain valve.

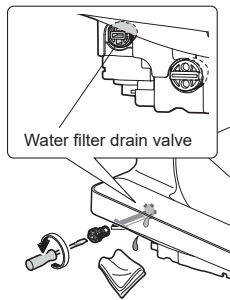

- (4) Drain the water from the water supply hose.
 - Insert the water filter drain valve and use a flat-head screwdriver to tighten it securely.

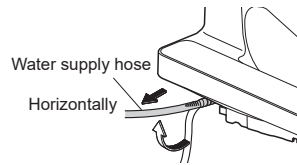

- (5) After draining the water, install the water filter drain valve.
 - Insert the water filter drain valve and use a flat-head screwdriver to tighten it securely.

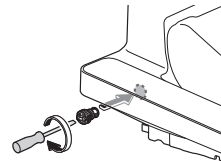

- (6) Insert the power plug.

- 4 Check that the **POWER LED** on the main display is lit up.

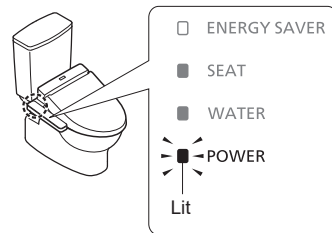

- 5 Set the water and toilet seat temperature to "High". (Page 18)
(To maintain the temperature.)
 - When finished, close the toilet seat and toilet lid.

To use the Washlet again

- The water needs to be resupplied. (Page 35)

Long Periods of Disuse

If the toilet is in a location you will not visit for a long time, drain the water. (The water in the tank may become contaminated and cause skin irritation or other problems.)

How to drain the water

- 1 Drain the water from the toilet tank. (Step 1 2 on Page 34)
- 2 Drain the pipe. (Step 3 (1) to (5) on Page 34)
- 3 Remove the water drain plug.
 - The water comes out from near the wand for about 90 seconds.

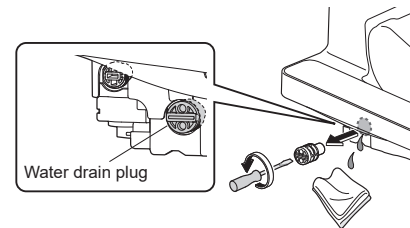

- 4 Reinstall the water drain plug.

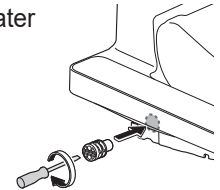

- Putting antifreeze in the water remaining in the toilet bowl will reduce its chance of freezing. (The antifreeze solution should not be flushed out. Collect it before using the toilet and dispose of it.)

To use the Washlet again

- The water needs to be resupplied. (See below)

Resupplying the Water

- 1 Open the shutoff valve.
 - Check that water is not leaking from a pipe or the main unit.
- 2 If the power is not turned ON, insert the power plug.
- 3 Discharge water from the wand.
 - (1) Pressing down the right side of the toilet seat,
 - (2) Press [REAR] on the control panel to discharge water from the wand for about two minutes. (It takes about one minute maximum before water comes out. Catch the water in a paper cup or other receptacle.)

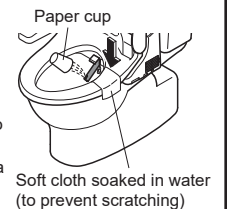

If the remaining water has frozen and no water comes out

- Heat the inside of the bathroom, and warm the water supply hose and shutoff valve using a cloth soaked in warm water.

Troubleshooting

First, try the actions described on pages 36 to 39. If the problem persists, consult the installer, seller or the contact listed on the back cover of this manual.

⚠ CAUTION

! If a water leak occurs, close the shutoff valve.

Please check first

Is the **POWER LED** lit?

- **SW2033R**
Is the **POWER LED** flickering?
→ The main unit is not mounted properly.
Mount the main unit again. (Page 26)
- **Is the breaker on the distribution board turned on?**
→ Check whether there is a power outage or the breaker has turned "OFF".

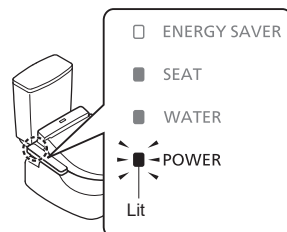

Is the **ENERGY SAVER LED** lit?

- **While the LED is lit, energy saver** (Page 20) **is in operation, so the toilet seat temperature may be reduced or the warm water heater and toilet seat heater may be turned off.**

Rear and Rear soft, front cleansing, wand

Trouble	Please check	Ref. Page
The wand (or cleansing water) does not come out	<ul style="list-style-type: none"> ● Did you sit on the toilet continuously for 2 hours or longer? (If so, operation is stopped for safety purposes.) → Stand up from the seat and then use again. 	-
	<ul style="list-style-type: none"> ● The seat switch will not turn on unless you sit on the seat properly. → Sit back on the toilet seat. 	11
	<ul style="list-style-type: none"> ● Are you using a toilet seat cover, a toilet lid cover or a seat for infants? → Remove any covers. When using a seat for infants or a soft highchair, remove after each use. 	11
The wand extends but the cleansing water does not come out /The cleansing water pressure is weak	<ul style="list-style-type: none"> ● Has a water failure occurred? → Press the "STOP" button and wait until water service is restored. 	-
	<ul style="list-style-type: none"> ● Is the shutoff valve closed? → Fully open the shutoff valve. 	14
	<ul style="list-style-type: none"> ● Is the water filter drain valve clogged with foreign matter? → Clean the filter. 	29
	<ul style="list-style-type: none"> ● Is the water pressure set to a low level? 	15
The cleansing water is cold	<ul style="list-style-type: none"> ● Is the water drain plug loosened? → Tighten the water drain plug securely. 	35
	<ul style="list-style-type: none"> ● Is the water temperature set to "OFF" or a low level? ● When the temperature of the water supply or the bathroom is low, the water temperature may be low when first sprayed. ● Is energy saver in operation? → Wait 10 minutes after having sat on the toilet seat. You can turn it "OFF" if the energy saver feature is "ON". 	18 - 22
	<ul style="list-style-type: none"> ● Is the water pressure set to a low level? 	15
Stops in the middle of use	<ul style="list-style-type: none"> ● Rear, rear soft and front cleansing stop automatically after 5 minutes of continuous use. ● Does the seat switch have difficulty detecting? → Sit back on the toilet seat. If you get up slightly from the seat, or sit forward on the seat, the seating switch may temporarily stop detecting your presence. 	- 11
Water comes out unexpectedly from the wand	<ul style="list-style-type: none"> ● Water may sometimes come out from around the wand when it expands in the warm water tank. 	-

Troubleshooting

Warm air drying (SW2033R only)

Trouble	Please check	Ref. Page
The dryer temperature is low	<ul style="list-style-type: none"> ● Is the dryer temperature set to low level? 	18
Stops in the middle of use	<ul style="list-style-type: none"> ● The feature stops automatically after 10 minutes of continuous use. ● Does the seat switch have difficulty detecting? → Sit back on the toilet seat. If you get up slightly from the seat, or sit forward on the seat, the seating switch may temporarily stop detecting your presence. 	- 11

Toilet Seat and Toilet Lid

Trouble	Please check	Ref. Page
The toilet seat is cold	<ul style="list-style-type: none"> ● Is the toilet seat temperature set to "OFF" or a low level? 	18
	<ul style="list-style-type: none"> ● Is the ENERGY SAVER LED (orange) lit? <ul style="list-style-type: none"> • When the SEAT LED (green) is also lit. → The toilet seat temperature has been lowered to save energy. When you sit, the toilet seat is temporarily heated. • When the SEAT LED is OFF. → Energy saver is operating and has turned off the toilet seat heater. When you sit on the seat, the toilet seat heater is turned on temporarily and the seat is warmed in about 15 minutes. You can turn it "OFF" if the energy saver feature is "ON". 	20
	<ul style="list-style-type: none"> ● Have you been seated for a long time? <ul style="list-style-type: none"> • After about 20 minutes of sitting, the temperature starts going down, and after about 1 hour, the toilet seat heater is turned "OFF". → Stand up from the seat and then use again. 	-
	<ul style="list-style-type: none"> ● Did you put anything on the toilet seat or the toilet lid? → Remove the object from the toilet seat or the toilet lid. 	-
	<ul style="list-style-type: none"> ● The seat switch will not turn on unless you sit on the seat properly. → Sit back on the toilet seat. 	11
	<ul style="list-style-type: none"> ● Is a toilet lid or seat cover installed? → Remove any covers. 	11

Energy Saver

Trouble	Please check	Ref. Page
The energy saver feature is not working	<ul style="list-style-type: none"> ● Because the function takes several days learning the usage conditions before starting energy saver, the amount of energy saving may be low, depending on the frequency of use. → Check the energy saver feature. 	20

Deodorizer (SW2033R only)

Trouble	Please check	Ref. Page
The deodorizer seems to be not working	<ul style="list-style-type: none"> ● Is "DEODORIZER" set to "OFF"? → Set to "ON". 	32
	<ul style="list-style-type: none"> ● Even after sitting down, you do not hear operation sounds. → Sit back on the toilet seat. ● If you hear an operation sound when you sit on the toilet seat. → Clean the deodorizing filter. 	11 25
A strange odor is emitted	<ul style="list-style-type: none"> ● Are you using an air freshener or deodorizer that you purchased separately? <ul style="list-style-type: none"> • Doing so may reduce the effectiveness of the Washlet deodorizer or cause strange odors. → Remove the air freshener or deodorizer. 	-

Others

Trouble	Please check	Ref. Page
Water is leaking from the plumbing connections	<ul style="list-style-type: none"> ● If the nut of the connecting pipe is loosened, retighten it by hand. (Do not use any tool.) → If the water leak does not stop, close the shutoff valve and seek repair. 	-
The main unit is unstable	<ul style="list-style-type: none"> ● There is clearance between the toilet seat cushion and the toilet bowl for activating the seat switch. When you sit on the toilet seat, the toilet seat subsides slightly to activate the seat switch. 	11
	<ul style="list-style-type: none"> ● Are the bolts that anchor the main unit loose? → Remove the main unit and then firmly tighten the base plate bolts. 	26
The main unit makes a sound	<p>Only when sitting on the toilet seat.</p> <ul style="list-style-type: none"> ● You hear operation sounds for preparing the pre-mist or spraying mist in the toilet bowl. → You can turn them "OFF". (SW2033R only) 	16 32
	<p>When moving away from the toilet bowl after use</p> <ul style="list-style-type: none"> ● You may hear the sound of the remaining water being drained. 	-
You feel air in the toilet bowl when sitting on the toilet seat (SW2033R only)	<ul style="list-style-type: none"> ● A mist is sprayed inside the toilet bowl to make it more difficult for dirt to adhere when sitting on the toilet seat. You may feel air when a mist is sprayed. → You can turn it "OFF". 	16 32

Specifications

Item		SW2033R	SW2014		
Rated power supply		AC 120 V 60 Hz			
Rated power consumption		408 W	290 W		
Type of water heater		Tank type			
Power cord length		1.2 m (3.93 ft)			
Water protection level		IPX4			
Functions	Cleansing	Spray volume	Rear cleansing	Approx. 0.27 to 0.43 L/min. (Approx. 0.07 to 0.11 gal/min.) <at 0.20 MPa (29 PSI) water pressure>	
			Rear soft cleansing	Approx. 0.27 to 0.43 L/min. (Approx. 0.07 to 0.11 gal/min.) <at 0.20 MPa (29 PSI) water pressure>	
			Front cleansing	Approx. 0.29 to 0.43 L/min. (Approx. 0.08 to 0.11 gal/min.) <at 0.20 MPa (29 PSI) water pressure>	
		Water temperature	Adjustable temperature range: OFF, about 35°C to 40°C (about 95°F to 104°F)		
		Toilet tank capacity	0.64 L (0.17 gal)		
		Heater capacity	225 W		
	Safety device	Temperature fuse, overheat shutoff switch (bimetal automatic return type), anti-idling float switch			
	Backflow prevention device	Vacuum breaker, Check valve			
	Warm air dryer	Warm air temperature*	Adjustable temperature range : about 35°C to 60°C (about 95°F to 140°F)	-	
		Airflow volume	Approx. 0.27 m ³ /min (Approx. 9.53 ft ³ /min)	-	
		Heater capacity	347 W	-	
		Safety device	Temperature fuse	-	
	Heated seat	Surface temperature	Adjustable temperature range: OFF, about 28°C to 36°C (about 82°F to 97°F) <About 26°C (about 79°F) when energy saver is in operation>		
		Heater capacity	52 W	50 W	
Safety device		Temperature fuse			
Deodorizer	Method	O ₂ deodorization	-		
	Airflow volume	Approx. 0.16 m ³ /min (Approx. 5.65 ft ³ /min)	-		
	Power consumption	Approx. 5.3 W	-		
Water supply pressure		Minimum required water pressure: 0.05 MPa (7.25 PSI) <dynamic>, Maximum required water pressure: 0.75 MPa (108.75 PSI) <static>			
Water supply temperature		0°C to 35°C (32°F to 95°F)			
Working ambient temperature		0°C to 40°C (32°F to 104°F)			
Dimensions		W 478 mm × D 490 mm × H 188 mm (W 1.57 ft × D 1.61 ft × H 0.62 ft)	W 478 mm × D 531 mm × H 188 mm (W 1.57 ft × D 1.74 ft × H 0.62 ft)		
Weight		About 5 kg (about 11 lb)			

* Temperature around the warm air outlet measured by TOTO.

Limited Warranty

One Year Limited Warranty

- TOTO warrants its washlet series ("Washlet") to be free from defects in materials and workmanship during normal use when properly installed and serviced, for a period of one (1) year from date of purchase. This limited warranty is extended only to the ORIGINAL PURCHASER of the Product and is not transferable to any third party, including but not limited to any subsequent purchaser or owner of the Product. This warranty applies only to TOTO Product is purchased and installed in USA, Canada.
- TOTO's obligations under this warranty are limited to repair, replacement or other appropriate adjustment, at TOTO's option, of the Product or parts found to be defective in normal use, provided that such Product was properly installed, used and serviced in accordance with instructions. TOTO reserves the right to make such inspections as may be necessary in order to determine the cause of the defect. TOTO will not charge for labor or parts in connection with warranty repairs or replacements. TOTO is not responsible for the cost of removal, return and/or reinstallation of the Product.
- This warranty does not apply to the following items:
 - Damage or loss sustained in a natural calamity such as fire, earthquake, flood, thunder, electrical storm, etc.
 - Damage or loss resulting from any accident, unreasonable use, misuse, abuse, negligence, or improper care, cleaning, or maintenance of the Product.
 - Damage or loss resulting from sediments or foreign matter contained in a water system.
 - Damage or loss resulting from the quality of water in the region where the product is used.
 - Damage or loss resulting from improper installation or from installation of the Product in a harsh and/or hazardous environment, or improper removal, repair or modification of the Product. This includes locations where the water pressure is above local codes or standards. (NOTE : Product model codes allow a maximum of 80 PSI. Check local codes or standards for requirements).
 - Damage or loss resulting from electrical surges or lightning strikes or other acts which are not the fault of TOTO or which the Product is not specified to tolerate, including failure to use the factory equipped cord and plug or use of a loose or faulty electrical outlet or use of a current or socket other than a 120V, 60Hz electrical current from a GFI (ground, fused) socket.
 - Damage or loss resulting from normal and customary wear and tear, such as gloss reduction, scratching or fading over time due to use, cleaning practices or water or atmospheric conditions, including but not limited to, the use of bleach, alkali, acid cleaners, dry (powder) cleaners or any other abrasive cleaners or the use of metal or nylon scrubbers.
- If the Danger Label which has been placed over the seams on the back of the Product's top unit is broken or otherwise not intact, this limited warranty is void.
- In order for this limited warranty to be valid, proof of purchase is required. TOTO encourages warranty registration upon purchase to create a record of Product ownership at <http://www.totousa.com>. Product registration is completely voluntary and failure to register will not diminish your limited warranty rights.
- If the Product is used commercially or is installed outside of USA, Canada, TOTO warrants the Product to be free from defects in materials and workmanship during normal use for one (1) year from the date of installation of the Product, and all other terms of this warranty shall be applicable except the duration of the warranty.
- This warranty gives you specific legal rights. You may have other rights which vary from state to state, province to province or country to country.
- To obtain warranty repair service under this warranty, you must take the Product or deliver it prepaid to a TOTO service facility together with proof of purchase (original sales receipt) and a letter stating the problem, or contact a TOTO distributor or products service contractor, or write directly to TOTO U.S.A., INC., 1155 Southern Road, Morrow, GA 30260 (888) 295 8134 or (678) 466-1300, if outside the U.S.A. If, because of the size of the Product or nature of the defect, the Product cannot be returned to TOTO, receipt by TOTO of written notice of the defect together with proof of purchase (original sales receipt) shall constitute delivery. In such case, TOTO may choose to repair the Product at the purchase's location or pay to transport the Product to a service facility.

WARNING! TOTO shall not be responsible or liable for any failure of, or damage to, this Product caused by either chloramines in the treatment of public water supply or cleaners containing chlorine (calcium hypochlorite).

NOTE: The use of a high concentrate chlorine or chlorine related product's can seriously damage the fittings. This damage can cause leakage and serious property damage.

THIS WRITTEN WARRANTY IS THE ONLY WARRANTY MADE BY TOTO. REPAIR, REPLACEMENT OR OTHER APPROPRIATE ADJUSTMENT AS PROVIDED UNDER THIS WARRANTY SHALL BE THE EXCLUSIVE REMEDY AVAILABLE TO THE ORIGINAL PURCHASER. TOTO SHALL NOT BE RESPONSIBLE FOR LOSS OF THE PRODUCT OR FOR OTHER INCIDENTAL, SPECIAL OR CONSEQUENTIAL DAMAGES OR EXPENSES INCURRED BY THE ORIGINAL PURCHASER, OR FOR LABOR OR OTHER COSTS DUE TO INSTALLATION OR REMOVAL, OR COSTS OF REPAIRS BY OTHERS, OR FOR ANY OTHER EXPENSE NOT SPECIFICALLY STATED ABOVE. IN NO EVENT WILL TOTO'S RESPONSIBILITY EXCEED THE PURCHASE PRICE OF THE PRODUCT. EXCEPT TO THE EXTENT PROHIBITED BY APPLICABLE LAW, ANY IMPLIED WARRANTIES, INCLUDING THAT OF MERCHANTABILITY OR FITNESS FOR USE OR FOR A PARTICULAR PURPOSE, ARE EXPRESSLY DISCLAIMED. SOME STATES DO NOT ALLOW LIMITATIONS ON HOW LONG AN IMPLIED WARRANTY LASTS, OR THE EXCLUSION OR LIMITATION OF INCIDENTAL OR CONSEQUENTIAL DAMAGES, SO THE ABOVE LIMITATION AND EXCLUSION MAY NOT APPLY TO YOU.

